

Tartalomjegyzék

Korlátpálcák, korlátpanelek	1
Korlátindító oszlopok	28
Talplemezek	29
Fűzhető közbenső díszek	30
Rozetták	32
C- és S-minták	38
Golyók, karikák	41
Korlátgömbök	42
Levelek, virágminták	43
Csúcsdíszek	46
Kerítéspálcák	49
Festékek, szegecsek	50
Kilincsek	51
Kapupántok/Házsámok	52
Bilincanyagok	53
Szálanyagok	54
Korláttetők	58
Végzárók	59
Rozsdamentes elemek	60
Kapuvasalatok	71

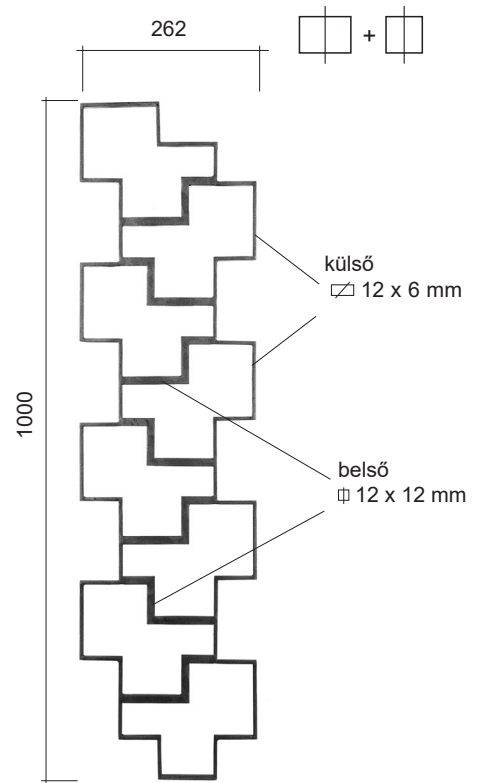

RGD 293/1
 □ 12×6 mm + □ 12 mm
 1000×262 mm

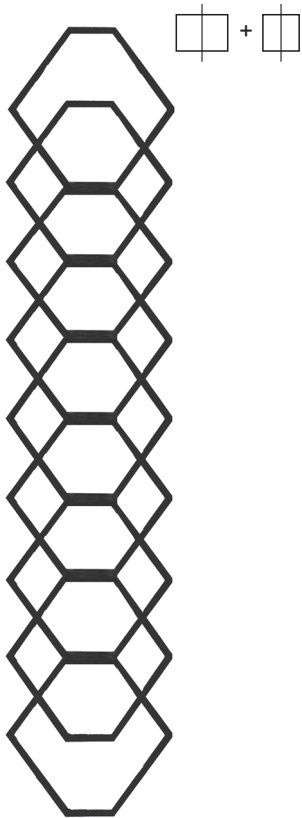

RGD 299/3
□ 16×8 mm + □ 8 mm
1000×200 mm



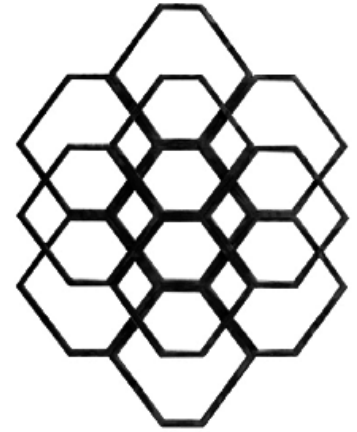

RGD 299/4
 □ 16×8 mm + □ 8 mm
 458×600 mm

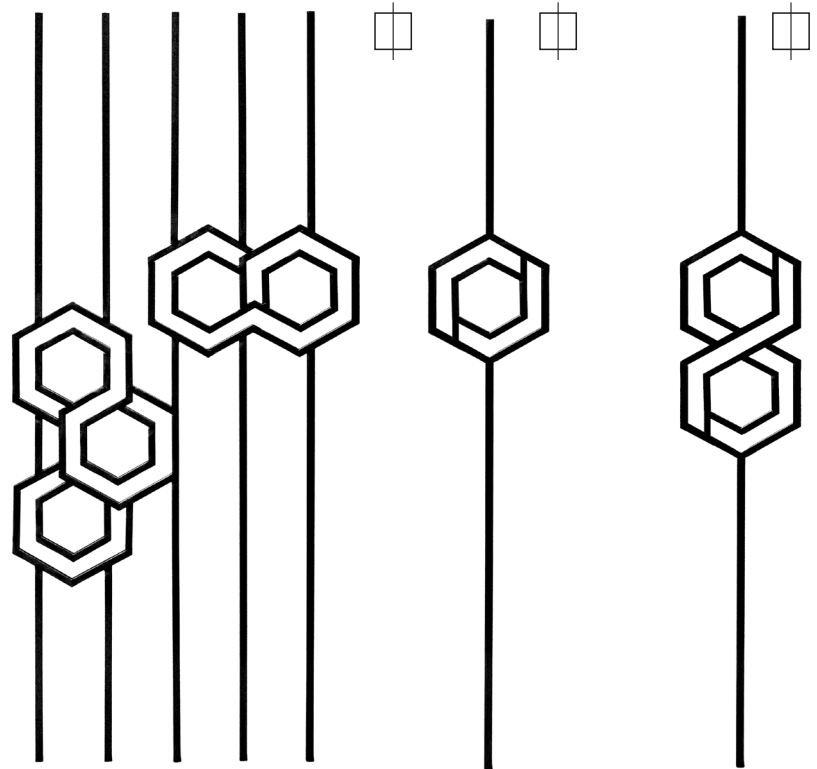
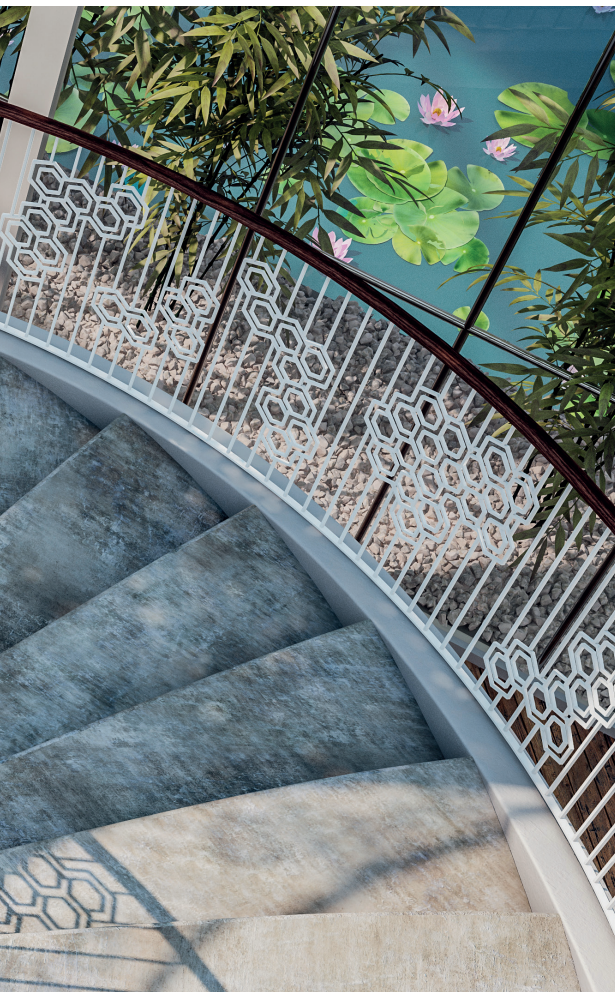

RGD 301/3
 □ 12 mm
 1000×568 mm

RGD 301/4
 □ 12 mm
 1000×197 mm

RGD 301/5
 □ 12 mm
 1000×197 mm

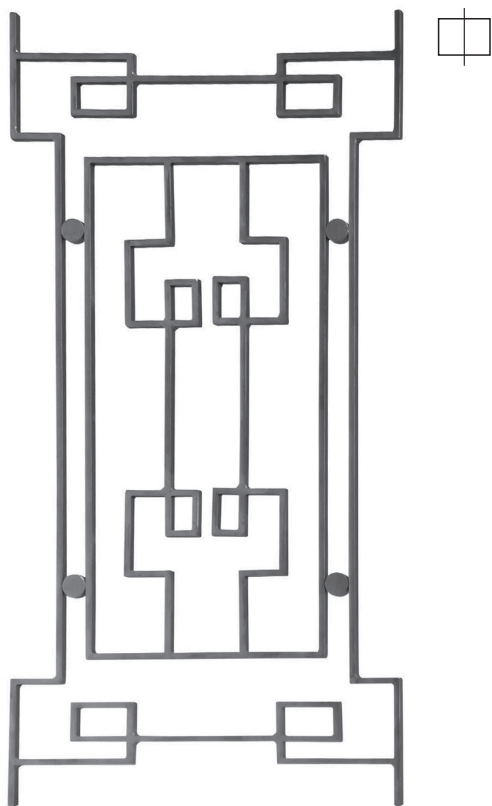

RGD 202/1
 ▧ 14×8 mm
 1000×500 mm



RGD 202/2
 ▧ 14×8 mm
 1000×95 mm



RGD 202/6
 ▧ 14×8 mm
 1000×80 mm

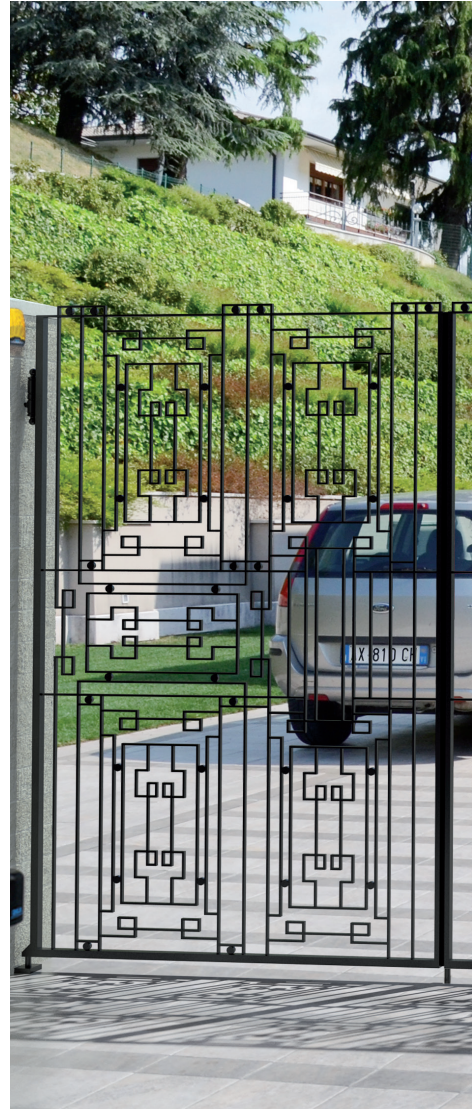

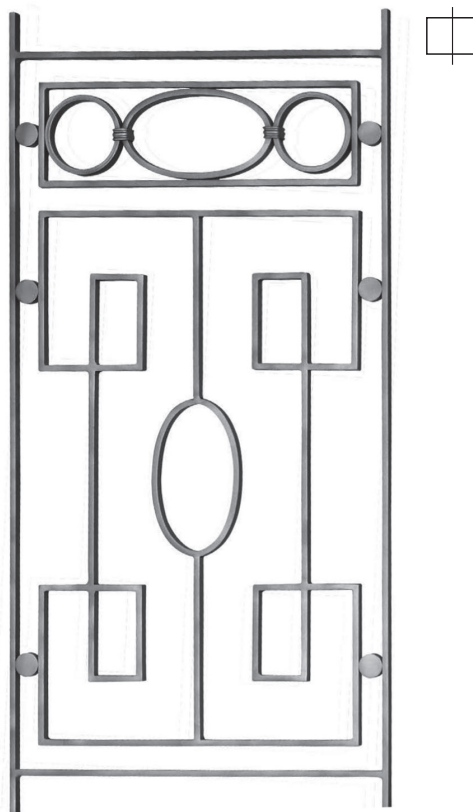
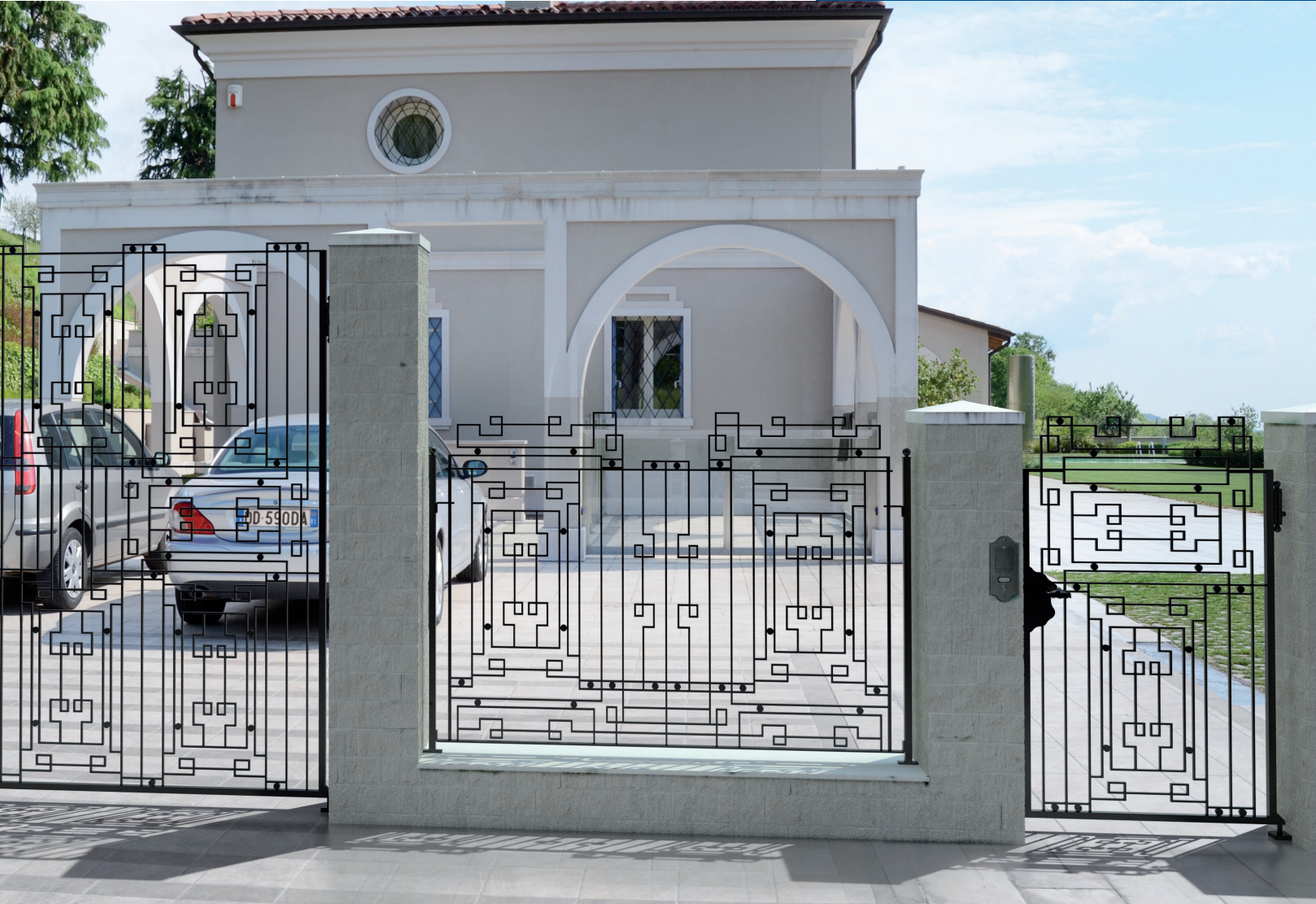

RGD 205/1
 ▧ 14×8 mm
 495×1000 mm

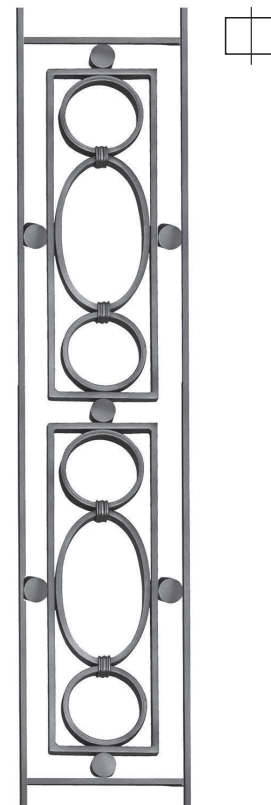

RGD 205/2
 ▧ 14×8 mm
 210×1000 mm

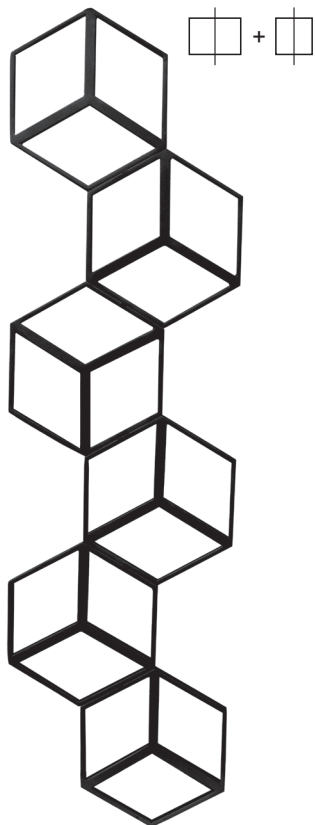

RGD 287/2
□ 12×6 mm + □ 12 mm
1000×274 mm





RGD 28/1
□ 14×14 mm
215×1000 mm



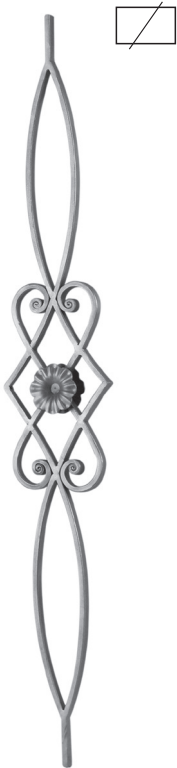

RGD 16/1
 □ 14×8 mm
 160×1000 mm



RGD 176/3
 □ 14×14 mm
 200×1000 mm



RGD 20/1
 □ 12×12 mm
 110×1000 mm



RGD 158/1
 □ 14×8 mm
 160×1000 mm



RGD 202/3
 □ 14×8 mm
 500×1000 mm

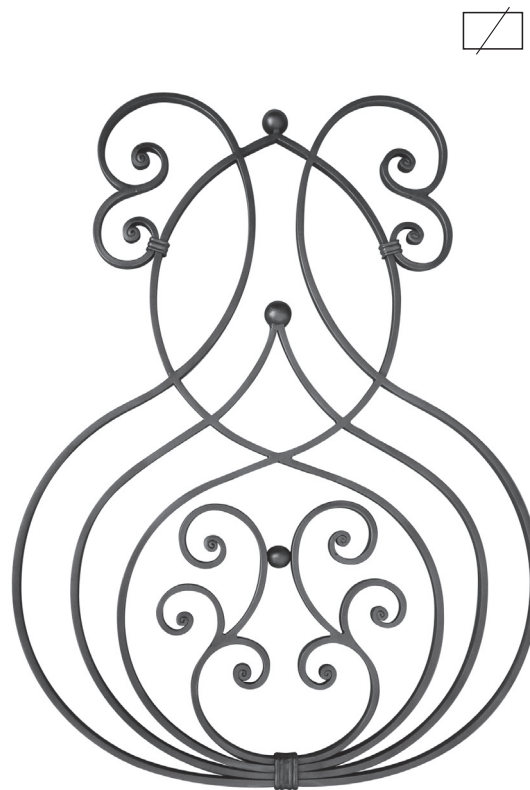

RGD 231/2
 □ 14×8 mm
 600 x 800 mm

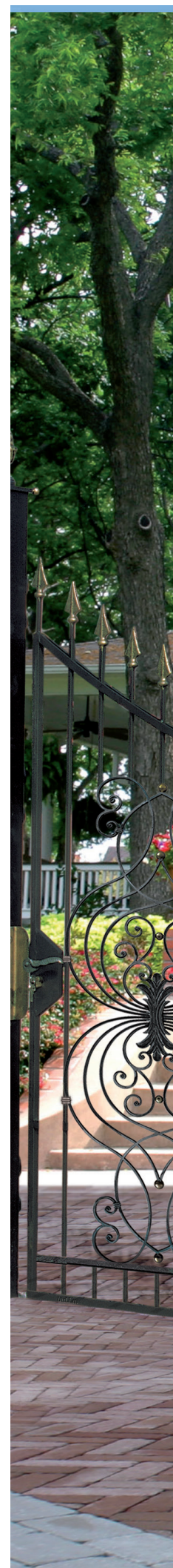





RGD 223/1
 ▣ 14×8 mm
 275×1000 mm





RF 9075/2
 ▣ 14×8 mm
 H 1000 mm



RGD 222/1
 ▣ 14×8 mm
 500×1000 mm

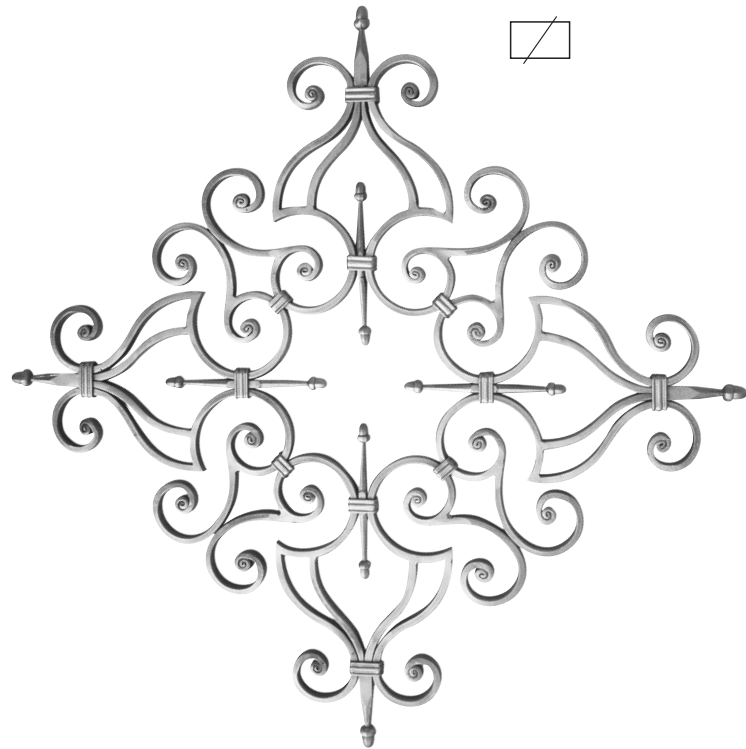



RGD 151/2
 14×8 mm
 770×500 mm



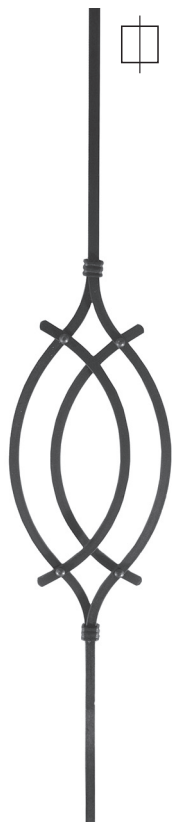

RGD 20/5
 □ 12×12 mm
 180×1000 mm

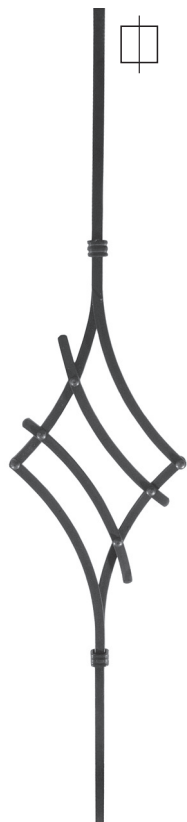

RGD 20/8
 □ 12×12 mm
 200×1000 mm

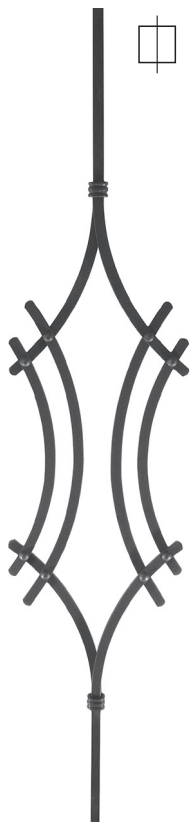

RGD 21/3
 □ 12×12 mm
 200×1000 mm

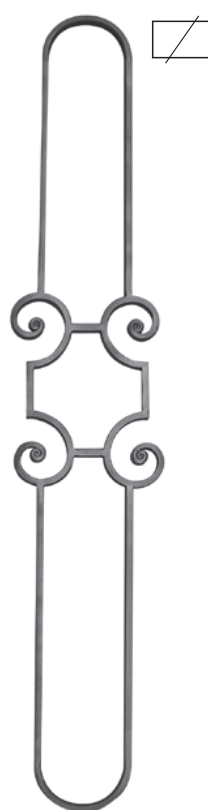

RGD 245/3
 ▤ 14×8 mm
 180×1000 mm



RGD 154/3
 □ 14×14 mm
 190×1000 mm



RGD 16/2
 ▤ 14×8 mm
 160×1000 mm



RGD 19/1
 ▤ 14×8 mm
 100×1000 mm



RGD 151/1
 □ 14×14 mm
 205×1000 mm



RGD 150/1
 ▤ 14×8 mm
 100×1000 mm



RGD 35/1
 □ 12×6 mm
 200×1000 mm

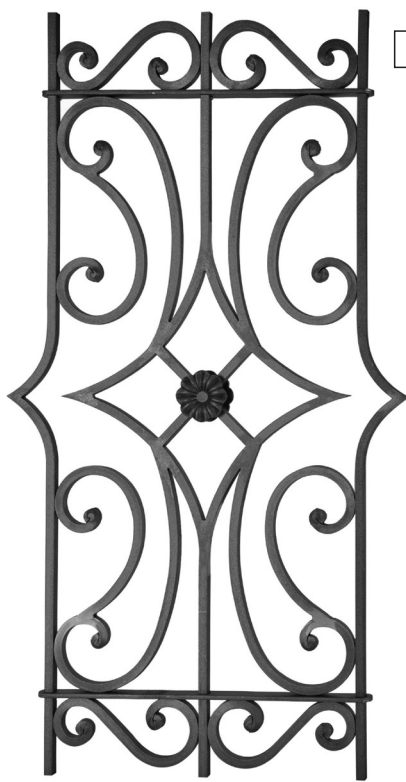

RGD 61/3
 □ 12×12 mm
 545 x 1000 mm



RF 9075
 □ 12×12 mm
 H 1000 mm



RGD 58/3
 □ 12×12 mm
 H 120×1000 mm



RGD 59/2
 □ 12×12 mm
 H 70×1000 mm



RGD 61/1
 □ 12×12 mm
 430 x 1000 mm

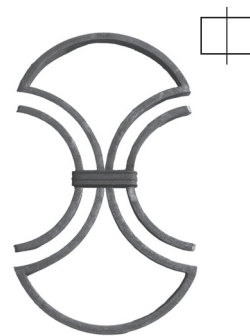

RGD 187/2
□ 14×8 mm
190×325 mm

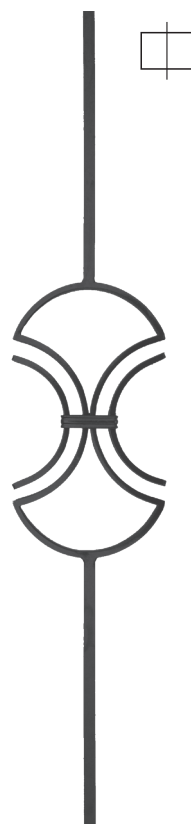

RF 9077
□ 14×8 mm
H 190×1000 mm

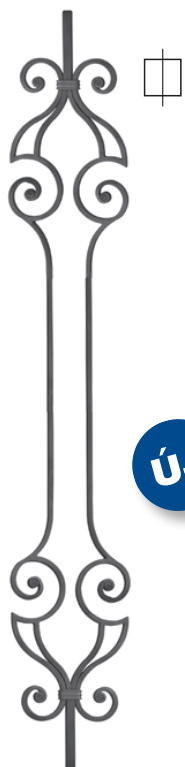

ÚJ

RGD 150/2
□ 14×14 mm
H 1000×205 mm

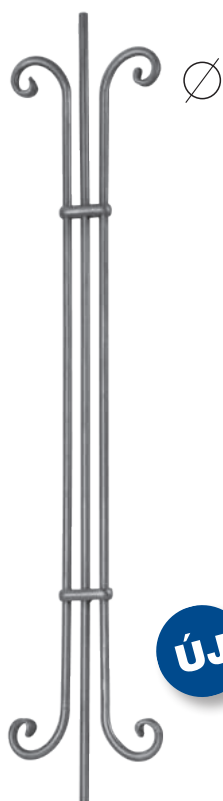

ÚJ

RGD 45/2
∅ 12 mm
H 1000×200 mm





R 497/1
 Ø 12 mm
 H 1000 mm

Korlátindító oszlop



R 797/5
 Ø 25 mm
 H 1200 mm



R 499/1
 Ø 12 mm
 H 1000 mm

Korlátindító oszlop



R 797/6
 Ø 25 mm
 H 1200 mm



R 496/C/1
 Ø 14 mm
 H 1000 mm



R 1770/1
 Ø 12 mm
 H 1000 mm



R 497/2
 Ø 12 mm
 H 1000 mm



R 499/2
 Ø 12 mm
 H 1000 mm



R 496/C/2
 Ø 14 mm
 H 1000 mm



R 503/1
 Ø 12 mm
 H 1000 mm



R 1184/4
 Ø 12 mm
 H 1000 mm



R 105/1
 □ 12×12 mm
 H 1000 mm

Korlátindító oszlop



R 112/7
 □ 25×25 mm
 H 1200 mm



R 50/5
 □ 12×12 mm
 H 900 mm

Korlátindító oszlop



R 113/6
 □ 30×30 mm
 H 1100 mm



RF 9054
 □ 12×12 mm
 H 205×1000 mm



R 105/2
 □ 12×12 mm
 H 1000 mm



R 50/6
 □ 12×12 mm
 H 900 mm



R 464/1
 ✕ 12×12 mm
 H 230×900 mm

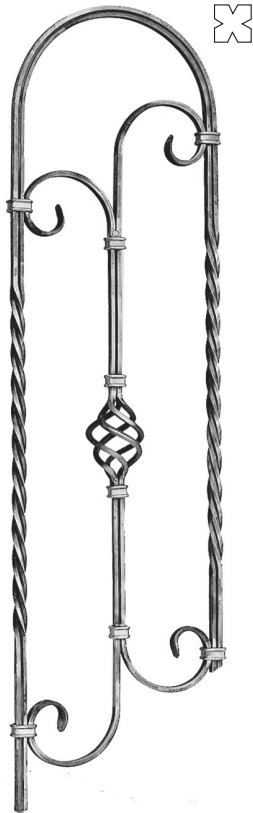

R 464/2
 ✕ 12×12 mm
 H 230×900 mm

Korlátindító
oszlop



R 1724/50
 ✕ 30×30 mm
 H 1200 mm



R 587/41
 ⊕ 12×12 mm
 H 830 mm



R 118/H/1
 ✕ 12×12 mm
 H 900 mm



R 118/H/2
 ✕ 12×12 mm
 H 900 mm



RF 9031
 ✕ 12×12 mm
 H 900 mm



R 587/45
 ⊕ 12×12 mm
 H 830 mm



R 1702/2
 □ 14×14 mm
 H 1000 mm

Korlátindító oszlop



R 1702/15
 □ 25×25 mm
 H 1200 mm

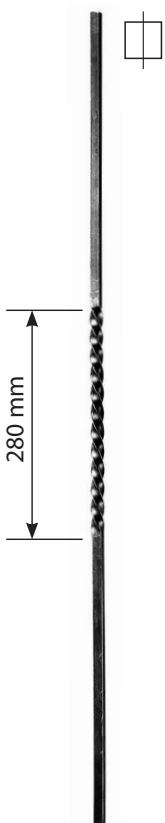

R 1148/5
 □ 12×12 mm
 H 1000 mm

Korlátindító oszlop



R GD 22/6
 □ 30×30 mm
 H 1200 mm



R 64/L/3
 Ø 14 mm
 H 900 mm

Korlátindító oszlop



R 1775/1
 Ø 25 mm
 H 1200 mm



R 1702/6
 □ 14×14 mm
 H 1000 mm



R 1148/8
 □ 12×12 mm
 H 1000 mm



R 64/L/4
 Ø 14 mm
 H 900 mm

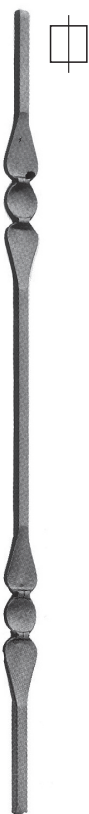

R 134/10
 □ 12×12 mm
 H 1000 mm



R 134/2
 □ 12×12 mm
 H 1000 mm



RF 9036
 □ 12×12 mm
 H 1000 mm

Korlátindító oszlop



R 1775/4
 □ 25×25 mm
 H 1200 mm



RF 9034
 □ 12×12 mm
 170×1000 mm



RF 9056
 □ 12×12 mm
 H 205x1000 mm



RF 9038
 □ 12×12 mm
 170×1000 mm



R 1701/1
 □ 12×12 mm
 H 1000 mm



R 1701/5
 □ 12×12 mm
 H 1000 mm



R 1701/3
 □ 12×12 mm
 H 1000 mm

Korlátindító oszlop



R 1701/15
 □ 25×25 mm
 H 1200 mm



RF 9039
 □ 12×12 mm
 170×1000 mm



RF 9040
 □ 12×12 mm
 H 1000 mm



RF 9042
 □ 12×12 mm
 170×1000 mm



R 1670/2
 □ 12×6 mm
 350×870 mm



R 1671/3
 □ 12×6 mm
 350×870 mm



R 52/1
 □ 12×6 mm
 350×870 mm



R 1670/1
 □ 12×6 mm
 360×1000 mm

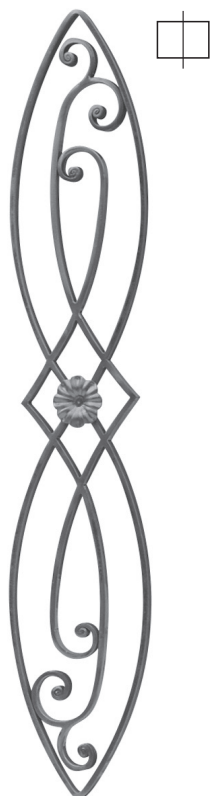

R 1681/1
 □ 14×8 mm
 190×1000 mm



R 1680/2
 □ 14×8 mm
 190×1000 mm



RF 9055
 ▤ 12×6 mm
 190×900 mm



R 471/1
 □ 14×8 mm
 250×900 mm



R 463/1
 □ 12×6 mm
 210×790 mm

Korlátindító oszlop



R 113/2
 □ 30×30 mm
 H 1100 mm



R 1171/2
 Ø 12 mm
 60×1000 mm



R 1171/1
 Ø 12 mm
 120×1000 mm



R 463/2
 □ 12×6 mm
 210×660 mm



RF 90100
 Ø 12 mm
 60×1000 mm



R 1730/1
 □ 12×12 mm
 H 1000 mm



R 1730/3
 □ 12×12 mm
 H 1000 mm



R 1730/5
 □ 12×12 mm
 H 1000 mm



R 1730/7
 □ 12×12 mm
 H 1000 mm



R 1720/11
 □ 12×12 mm
 H 1000 mm



R 149/1
 ∅ 30 mm
 H 900 mm



R 1718/7
 □ 12×12 mm
 H 1000 mm



RF 9015
 ⬡ 12×12 mm
 H 1000 mm



RF 9018
 ⬡ 12×12 mm
 H 1000 mm



RF 9050
 ⬡ 12×12 mm
 H 1000 mm



R 578/1
 12×12 mm
 H 900 mm

R 578/2
 14×14 mm
 H 900 mm



R 578/3
 12×12 mm
 H 900 mm

R 578/4
 14×14 mm
 H 900 mm

RF 9026
 12×12 mm
 H 170×900 mm



RF 9025
 12×12 mm
 H 900 mm



Korlátindító oszlop



R 801/2
 25×25 mm
 H 1200 mm



RF 9030
 12×12 mm
 100×900 mm



RF 9024
 12×12 mm
 200×900 mm

Virág csak az egyik oldalon

R 578/5
 12×12 mm
 110×900 mm



RF 9027
 12×12 mm
 150×900 mm



Virág csak az egyik oldalon



**CSAK
A KÉSZLET
EREJÉIG!**

R 64/H/1
□ 12×12 mm
H 900 mm



**CSAK
A KÉSZLET
EREJÉIG!**

RF 9092
□ 12×12 mm
H 900 mm



**CSAK
A KÉSZLET
EREJÉIG!**

RF 9094
□ 12×12 mm
H 900 mm



**CSAK
A KÉSZLET
EREJÉIG!**

RF 9095
□ 12×12 mm
H 900 mm



**CSAK
A KÉSZLET
EREJÉIG!**

RF 9096
□ 12×12 mm
H 900 mm



R 586/6
□ 12×12 mm
H 1000 mm



R 1701/13
□ 12×12 mm
H 1000 mm



R 1787/3
□ 32×5 mm
H 1000 mm



R 1789/2
□ 32×5 mm
H 800 mm



R 1787/4
□ 31×5 mm
H 1000 mm



R 1789/4
□ 31×5 mm
H 800 mm

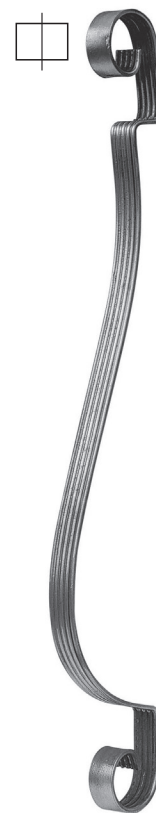

R 1276/1
□ 30×5 mm
140×800 mm



R 1780/7
 ⌀ 12×12 mm
 H 1000 mm



RF 9089
 ⌀ 12×12 mm
 H 1000 mm



RF 9090
 ⌀ 12×12 mm
 H 1000 mm



RF 9091
 ⌀ 12×12 mm
 H 1000 mm

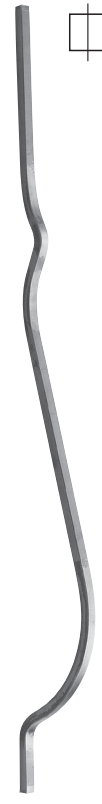

R 1779/7
 □ 12×12 mm
 H 1000 mm



R 70/D/5
 □ 14×14 mm
 H 900 mm



R 47/6
 ⌀ 12×12 mm
 H 900 mm



RF 9045
 ⌀ 12×12 mm
 150×900 mm



RF 9046
 ⌀ 12×12 mm
 170×900 mm



RF 9084
 ⌀ 12×12 mm
 H 900 mm



RF 9088
 ⌀ 12×12 mm
 H 900 mm



R 578/17
 ⌀ 12×12 mm
 H 900 mm

R 578/19
 ⌀ 14×14 mm
 H 900 mm



R 112/9
 30×30 mm
 H 1200 mm



R 112/11
 30×30 mm
 H 1200 mm



R 1724/26
 30×30 mm
 H 1200 mm



R 1725/12
 30×30 mm
 H 1200 mm



RF 9103/1
 25×25 mm
 H 1200 mm



R 146/2
 Ø 40 mm
 H 1000 mm



RF 9115
 30×30 mm
 H 1200 mm



RF 9114
 30×30 mm
 H 1000 mm

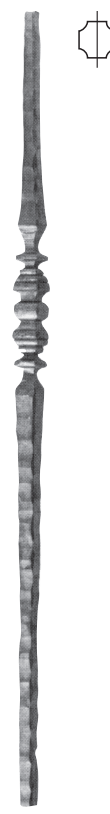

R 112/10
 30×30 mm
 H 1200 mm



RF 9112
 30×30 mm
 H 1200 mm

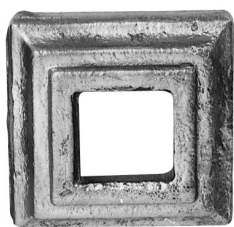

R 819/1
 □ 60×60 mm
 furat □ 30 mm

R 819/2
 □ 60×60 mm
 furat □ 25 mm

R 819/3
 □ 50×50 mm
 furat □ 20 mm

R 819/16
 □ 80×80 mm
 furat □ 40 mm



R 1408/6
 Ø 60 mm
 furat Ø 31 mm

R 1408/7
 Ø 60 mm
 furat Ø 25 mm



R 1408/1
 □ 80×80 mm
 furat □ 26 mm

R 1408/2
 □ 55×55 mm
 furat □ 15 mm



RN 0050
 ▽ 6 mm
 100×220 mm



R 1857/13
 Ø 82 mm
 ▽ 4 mm



R 1393/7
 Ø 68×10 mm
 furat Ø 12,5 mm

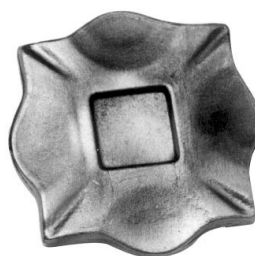

R 116/A/6
 □ 100×100 mm
 ▽ 10 mm

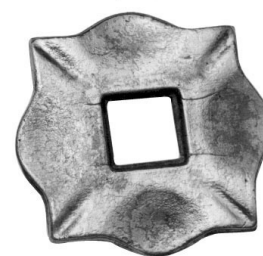

R 116/A/7
 □ 100×100 mm
 ▽ 10 mm
 furat □ 30×30 mm



R 802/4
 □ 120×120 mm
 ▽ 10 mm

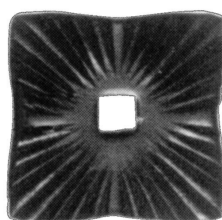

R 116/A/2
 □ 75×75 mm
 ▽ 5 mm

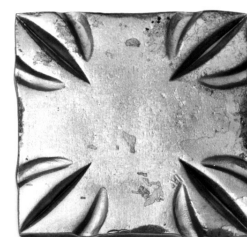

R 94/A/3
 □ 100×100 mm
 ▽ 8 mm

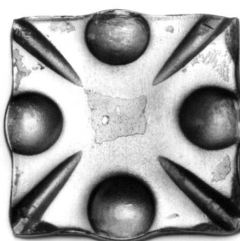

R 94/A/6
 □ 80×80 mm
 ▽ 8 mm

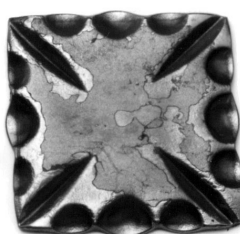

R 94/A/4
 □ 80×80 mm
 ▽ 8 mm

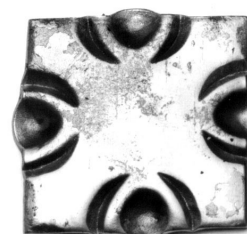

R 94/A/5
 □ 80×80 mm
 ▽ 8 mm



- R 158/B/1 12×12 mm, 55×130 mm
- R 158/B/2 15×15 mm, 60×145 mm
- R 158/B/3 21×21 mm, 80×170 mm
- R 158/B/4 24×24 mm, 95×220 mm

R 747/12
40×65 mm
furat □ 12 mm



R 747/13
40×65 mm
furat □ 14 mm



R 746/1
40×45 mm
furat □ 12 mm



R 746/5
40×65 mm
furat □ 14 mm



R 746/6
40×38 mm
furat □ 14 mm

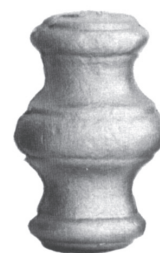

R 128/7
Ø 37×63 mm
furat Ø 14,5 mm



R 747/15
Ø 40×39 mm
furat □ 12 mm



R 1390/5
40×40×65 mm
furat □ 17 mm



R 128/2
Ø 40×23 mm
furat □ 14,5 mm

R 128/38
Ø 40×23 mm
furat □ 12,5 mm



R 1244/4
Ø 30×150 mm
furat Ø 13 mm



R 1244/16
Ø 30×155 mm
furat Ø 13 mm



R 1244/17
Ø 30×145 mm
furat Ø 13 mm



R 154/B/3
Ø 40×120 mm
furat Ø 14 mm



R 159/1	8×8 mm,	35×90 mm
R 159/3	12×12 mm,	60×125 mm
R 159/4	14×14 mm,	60×125 mm
R 159/5	16×16 mm,	80×165 mm
R 159/6	20×20 mm,	80×165 mm
R 159/7	24×24 mm,	95×180 mm
R 159/9	30×30 mm,	100×220 mm
R 159/10	40×40 mm,	30×280 mm



R 158/B/7
Ø 70 mm



R 741/8
Ø 69×78 mm
furat □ 30 mm



RF 1389/2
□ 12 mm
35×100 mm



R 1389/5
□ 12 mm
30×150 mm



R 1389/4
□ 12 mm
30×150 mm



R 1389/6
Ø 12 mm
30×150 mm



R 1389/1
□ 12 mm
33×200 mm



R 154/A/1
Ø 40×105 mm
furat Ø 14 mm



R 1854/3
Ø 35×40 mm
furat □ 13 mm



R 1854/1
Ø 35×40 mm
furat Ø 13 mm



RGD 269/3
 □ 14×14 mm
 600 x 700 mm

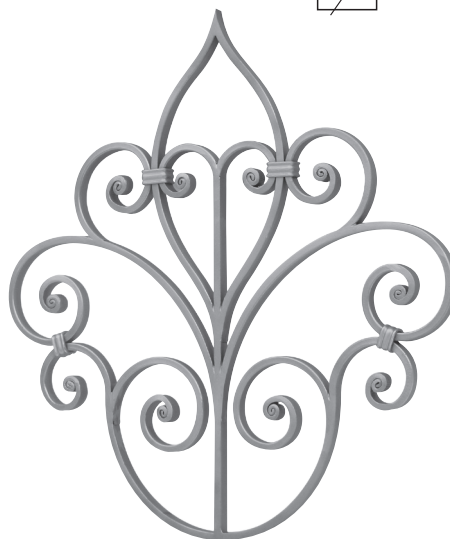

RGD 234/2
 □ 14×8 mm
 500 x 520 mm

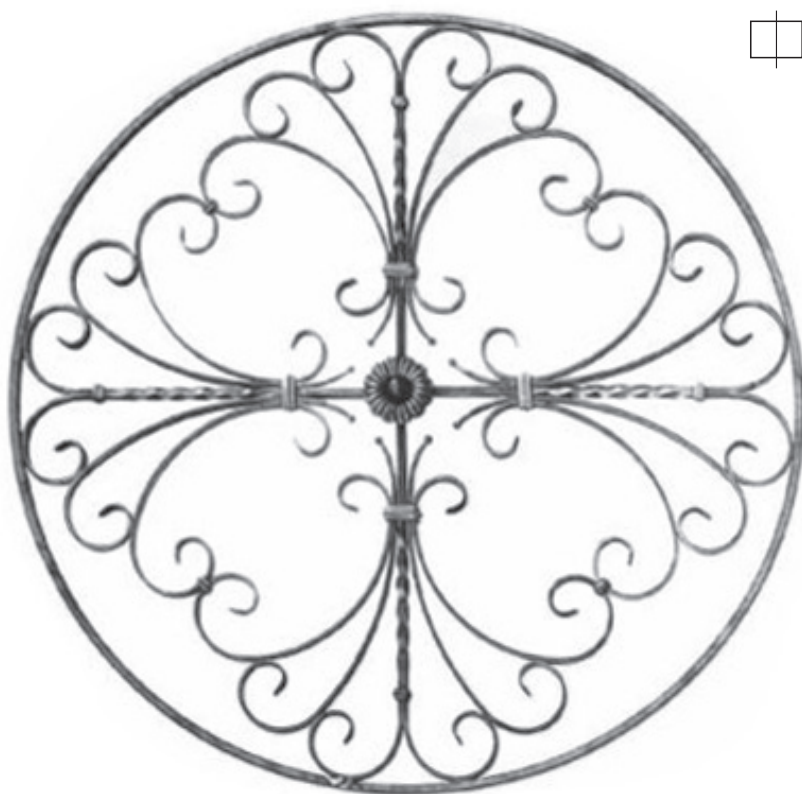

R 457/2
 □ 12×6 mm
 Ø 1045 mm



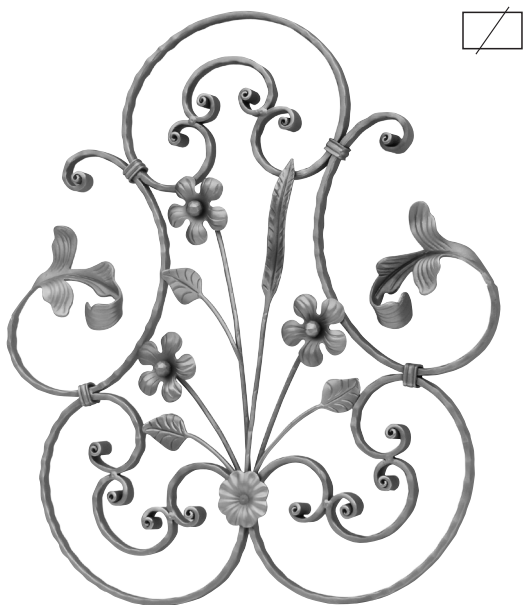

RGD 269/1
 □ 16×8 mm
 670 x 710 mm



RGD 268/2
 □ 14×8 mm
 Ø 630 mm



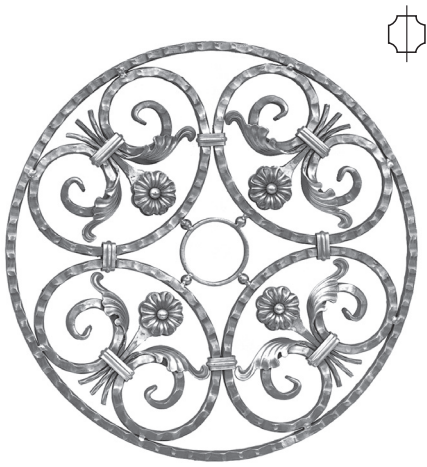

R 459/1
 □ 14×14 mm
 Ø 610 mm

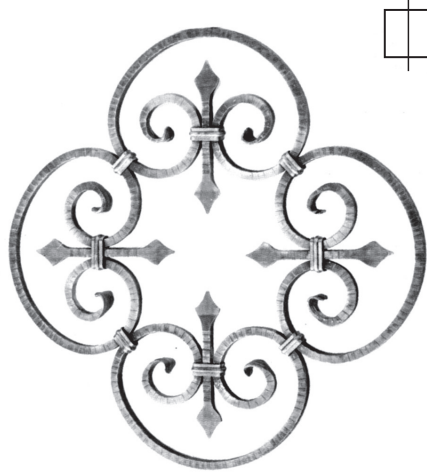

R 24/3
 □ 12×12 mm
 Ø 600 mm

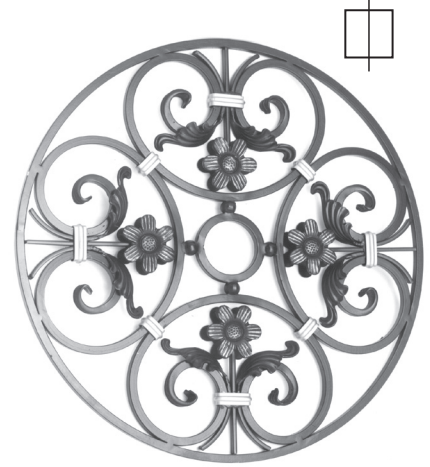

R 24/E/1
 □ 12×12 mm
 Ø 600 mm

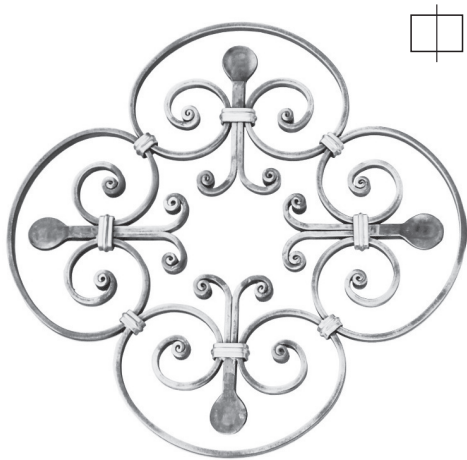

R 1655/1
 □ 12×6 mm
 Ø 430 mm

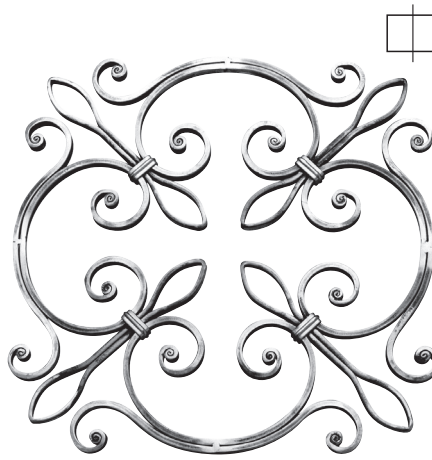

R 1667/2
 □ 14×8 mm
 Ø 470 mm

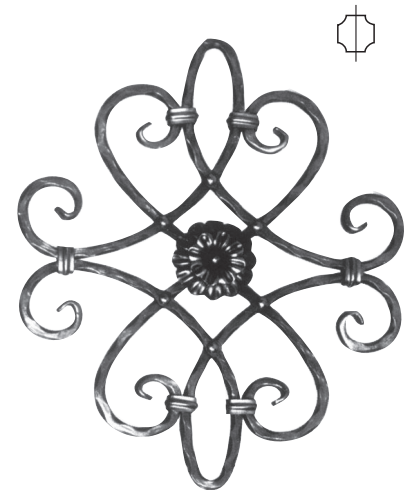

R 26/C/1
 □ 12×12 mm
 430×530 mm



RN 0001
 □ 14×8 mm
 Ø 500 mm



R 1661/1
 □ 12×6 mm
 Ø 370 mm



R 720/2
 □ 12×6 mm
 Ø 415 mm

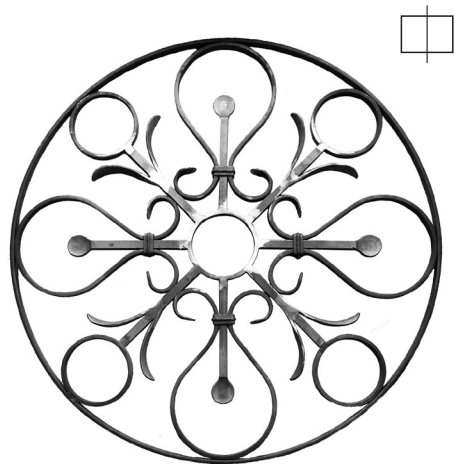

R 1024/1
 □ 12×6 mm
 ∅ 615 mm

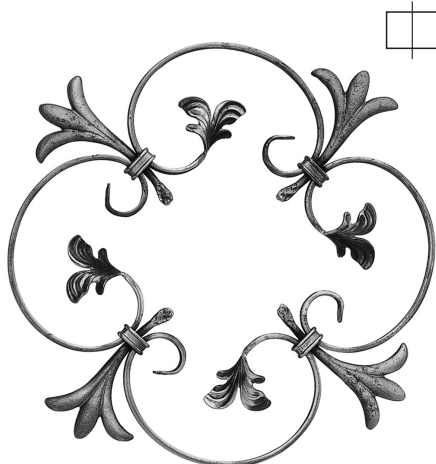

R 449/1
 □ 12×6 mm
 ∅ 430 mm

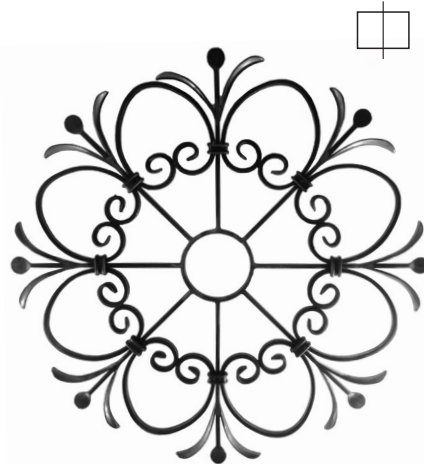

R 1020/1
 □ 12×6 mm
 ∅ 590 mm



R 1647/1
 □ 12×6 mm
 610×440 mm



R 679/1
 ∅ 12 mm
 470×470 mm

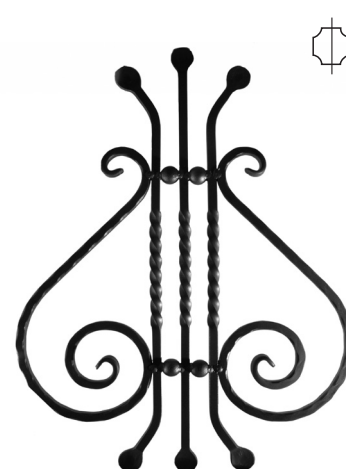

R 460/2
 □ 12×12 mm
 460×600 mm



R 1647/3
 □ 12×6 mm
 200×500 mm

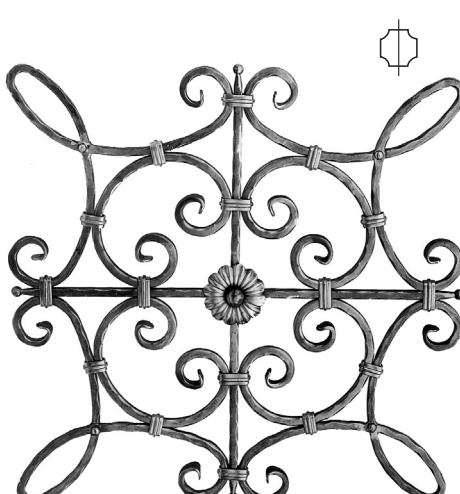

R 480/1
 □ 12×12 mm
 660×660 mm

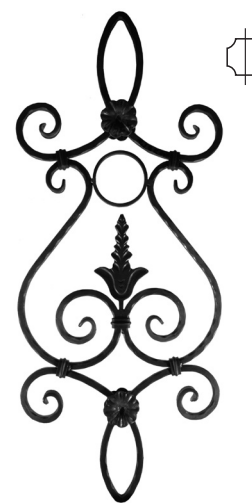

R 475/2
 □ 12×12 mm
 380×900 mm

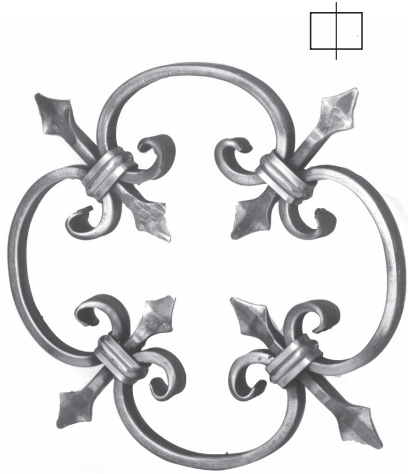

R 21/5
 ▧ 14×8 mm
 Ø 275 mm

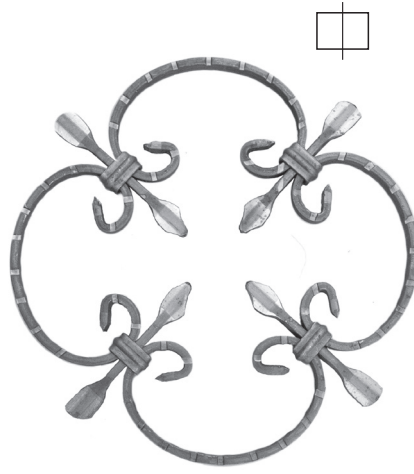

R 23/1
 ▧ 10×5 mm
 Ø 250 mm



R 23/2
 ▧ 20×4 mm
 Ø 250 mm

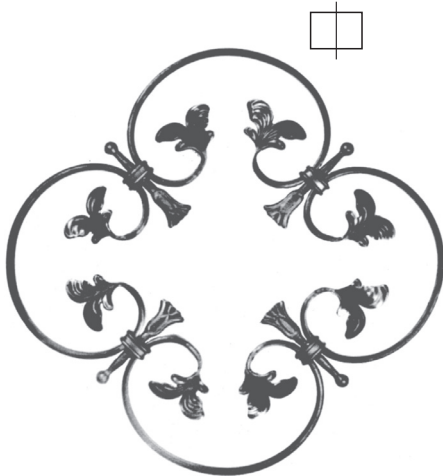

R 24/B/1
 ▧ 12×6 mm
 Ø 460 mm

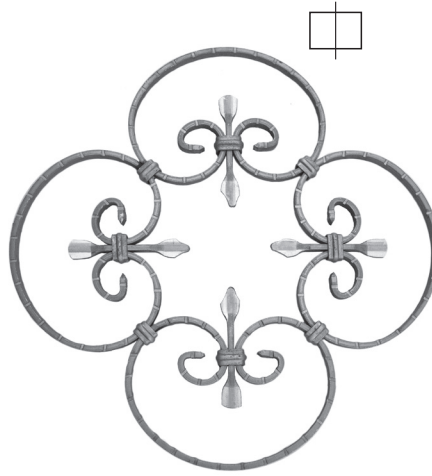

R 24/1
 ▧ 10×5 mm
 Ø 380 mm

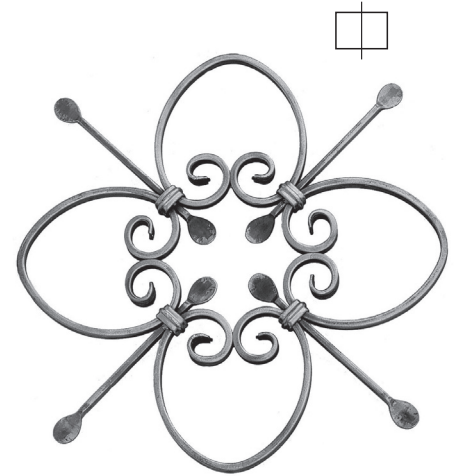

R 1009/2
 ▧ 12×6 mm
 Ø 370 mm



R 24/F/2
 ▧ 12×12 mm
 300×220 mm

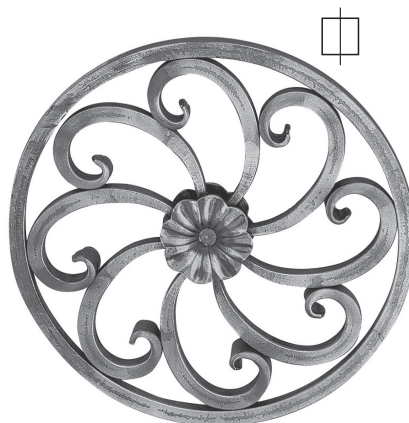

R 1013/2
 ▧ 12×12 mm
 Ø 295 mm

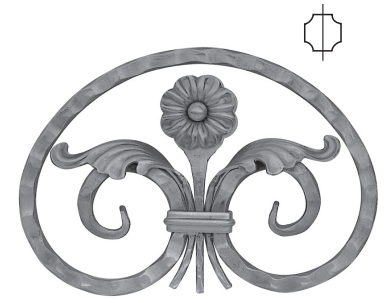

R 458/1
 ▧ 14×14 mm
 300×210 mm

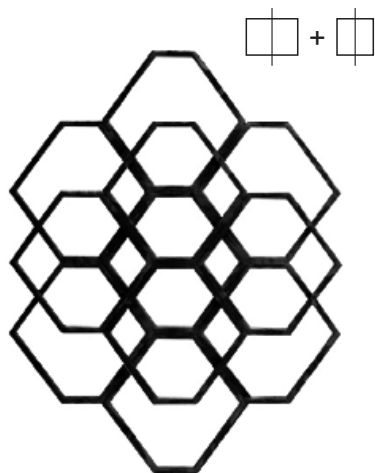

RGD 299/4
 □ 16×8 mm + □ 8 mm
 458×600 mm

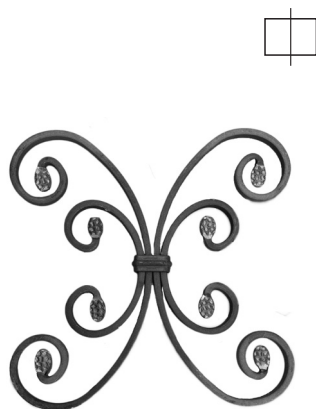

R 33/2
 □ 12×6 mm
 250×250 mm

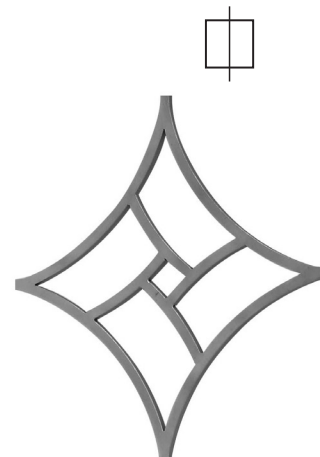

RGD 211/2
 □ 12×12 mm
 395×395 mm

□ 12x12 mm-es anyagra fűzhető

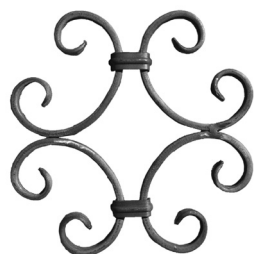

RF 9325
 □ 12×6 mm
 195×195 mm



RF 9315
 □ 12×6 mm
 155×105 mm



RF 9316
 □ 12×6 mm
 190×140 mm



RF 9317
 □ 12×6 mm
 190×140 mm



RF 9319
 □ 12×6 mm
 130×105 mm

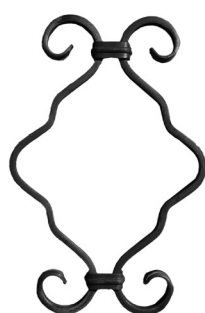

RF 9320
 □ 12×6 mm
 160×250 mm

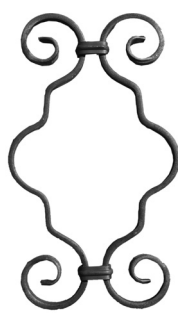

RF 9321
 □ 12×6 mm
 170×290 mm



RF 9322
 □ 12×6 mm
 110×230 mm



RF 9323
 □ 12×6 mm
 240×480 mm



R 35/1
 □ 12×6 mm
 205×445 mm



RF 9326
 □ 12×6 mm
 170×350 mm



R 80/A/1	12×6 mm	110×270 mm
R 80/A/28	14×6 mm	110×270 mm
R 80/A/11	12×6 mm	65×150 mm
R 80/A/12	12×6 mm	70×190 mm
R 80/A/27	14×6 mm	70×190 mm



R 87/1	12×6 mm	80×130 mm
R 87/5	12×6 mm	90×160 mm
R 87/6	12×6 mm	80×150 mm
R 88/A/3	12×6 mm	70×110 mm
R 88/9	12×6 mm	125×250 mm



R 74/2	12×6 mm	120×360 mm
--------	---------	------------



R 80/C/15	12×6 mm	80×290 mm
-----------	---------	-----------



R 86/5	12×6 mm	95×210 mm
--------	---------	-----------



R 64/G/6	12×6 mm	50×230 mm
----------	---------	-----------



R 64/G/5	12×6 mm	60×105 mm
----------	---------	-----------



R 64/G/4	12×6 mm	60×105 mm
----------	---------	-----------



R 80/A/3	12×6 mm	60×110 mm
R 80/A/29	14×6 mm	60×110 mm



R 80/A/13	12×6 mm	110×150 mm
R 80/A/30	14×6 mm	110×150 mm



R 88/H/2	12×6 mm	75×150 mm
R 88/H/3	12×6 mm	75×130 mm
R 88/H/4	12×6 mm	75×160 mm
R 80/B/8	12×6 mm	75×120 mm



R 80/A/9	12×6 mm	70×105 mm
R 80/A/10	12×6 mm	95×140 mm
R 80/A/25	14×6 mm	95×140 mm



R 92/B/3	12×6 mm	80×350 mm
----------	---------	-----------



R 64/G/3	12×6 mm	105×150 mm
----------	---------	------------

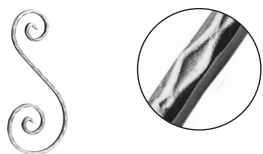

R 641/6 \square 12×6 mm 120×290 mm



R 641/1 \square 12×6 mm 70×105 mm

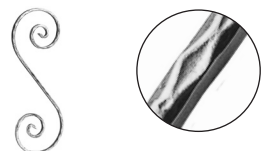

R 641/8 \square 12×6 mm 120×360 mm



R 641/2 \square 12×6 mm 70×130 mm



R 641/3 \square 12×6 mm 60×115 mm



R 491/6 \square 12×6 mm \varnothing 100 mm
 R 1319/16 \square 12×6 mm \varnothing 115 mm
 R 1319/17 \square 12×6 mm \varnothing 130 mm

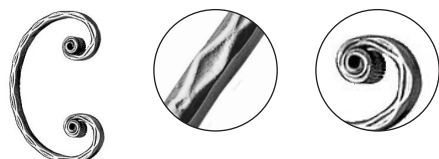

R 1296/7 \square 12×6 mm 90×140 mm



R 1296/8 \square 12×6 mm 70×115 mm

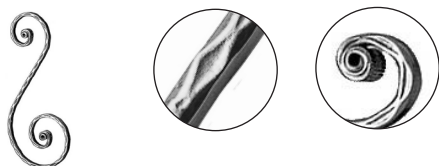

R 1296/3 \square 12×6 mm 120×290 mm

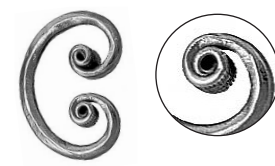

R 1296/13 \varnothing 12 mm 70×110 mm



R 658/7 \square 12×12 mm 80×130 mm



R 491/8 \square 12×12 mm \varnothing 100 mm
 R 1317/1 \square 12×12 mm \varnothing 115 mm
 R 1802/77 \square 12×12 mm \varnothing 120 mm
 R 1317/2 \square 12×12 mm \varnothing 130 mm



R 78/B/2 \square 12×12 mm 110×220 mm



RN 0066
 □ 12×6 mm
 90×140 mm

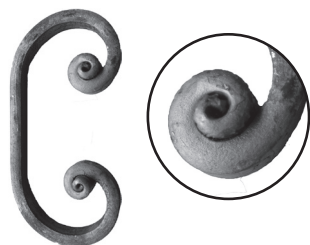

RN 0068
 □ 12×6 mm
 55×115 mm



RN 0070
 □ 12×6 mm
 120×360 mm



RN 0073
 □ 12×6 mm
 115×240 mm



R 88/P/1
 □ 14×8 mm
 130×290 mm



R 88/E/5
 □ 12×6 mm
 75×250 mm



R 86/4
 □ 12×6 mm
 75×220 mm



R 76/1
 □ 12×6 mm
 100×320 mm



RF 9218/B
 □ 12×6 mm
 110×270 mm



RF 9218/J
 □ 12×6 mm
 110×270 mm



RGD 262/3
 □ 14×8 mm
 100×230 mm



RGD 262/4
 □ 14×8 mm
 100×240 mm



RGD 263/3
 □ 14×8 mm
 100×220 mm



RF 9309
 □ 12×6 mm
 100×600 mm



RF 9309/1
 □ 12×6 mm
 100×600 mm

kovácsolt golyó

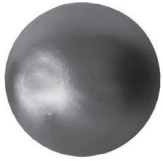

R 117/1	∅ 16
R 116/F/1	∅ 20
R 116/F/2	∅ 25
R 116/F/3	∅ 30
R 123/1	∅ 35
R 116/F/4	∅ 40
R 116/F/5	∅ 50
R 116/F/6	∅ 60
R 116/F/7	∅ 70
R 116/F/8	∅ 80
R 116/F/9	∅ 90
R 116/F/10	∅ 100

üreges gömb furattal



anyagvastagsága: \sphericalangle 2 mm

R 1394/25	∅ 25,	furat ∅ 12,5 mm
R 1394/24	∅ 30,	furat ∅ 12,5 mm
R 1394/23	∅ 40,	furat ∅ 12,5 mm
R 1394/22	∅ 50,	furat ∅ 12,5 mm
R 1394/21	∅ 60,	furat ∅ 12,5 mm



R 1299/5	\sphericalangle 12×6 mm	∅ 100 mm
R 1299/6	\sphericalangle 12×6 mm	∅ 130 mm



R 157/1	\sphericalangle 12×6 mm	∅ 100 mm
R 157/2	\sphericalangle 12×6 mm	∅ 115 mm
R 1802/25	\sphericalangle 12×6 mm	∅ 120 mm
R 157/3	\sphericalangle 12×6 mm	∅ 130 mm



CSAK A KÉSZLET EREJÉIG!

R 1803/1	\sphericalangle 12×6 mm	∅ 100 mm
R 1803/2	\sphericalangle 12×6 mm	∅ 115 mm
R 1803/3	\sphericalangle 12×6 mm	∅ 130 mm



rovátkolt

R 491/3	\sphericalangle 12×6 mm	∅ 100 mm
R 491/4	\sphericalangle 12×6 mm	∅ 115 mm
R 491/5	\sphericalangle 12×6 mm	∅ 130 mm





R 116/A/19
Ø 55 mm



R 116/A/20
Ø 55 mm



R 1404/8
Ø 50 mm, H 75 mm
□ 40×40 mm



R 749/2
Ø 50 mm
H 95 mm



R 128/35
Ø 50 mm
H 90 mm



R 167/15
□ 30×30 mm



R 113/10
70×130 mm

R 167/16
□ 40×40 mm



R 749/17 □ 25 mm, H 60 mm
R 749/18 □ 40 mm, H 85 mm
R 749/19 □ 60 mm, H 125 mm
R 749/20 □ 80 mm, H 150 mm



R 749/7 Ø 28 mm, H 55 mm
R 749/8 Ø 43 mm, H 85 mm
R 749/9 Ø 55 mm, H 120 mm
R 749/10 Ø 70 mm, H 150 mm
R 749/11 Ø 90 mm, H 190 mm





R 661/3
8 mm
110×155 mm



R 661/4
8 mm
75×125 mm



R 675/12
3 mm
80×110 mm



R 675/13
3 mm
80×110 mm



R 675/14
60×85 mm



R 675/15
60×85 mm



R 136/3
3 mm
70×60 mm



R 136/4
3 mm
70×60 mm

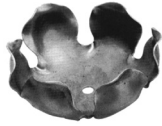

R 136/5
0,3 mm
65×30 mm

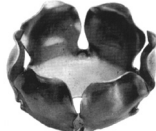

R 136/6
0,3 mm
55×33 mm



R 136/7
0,3 mm
38×40 mm



R 136/1
3 mm
40×110 mm
R 136/13
3 mm
30×90 mm



R 136/2
3 mm
40×110 mm
R 136/12
3 mm
30×90 mm

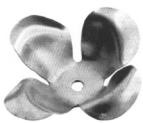

R 136/9
0,3 mm
48×15 mm



R 136/10
3 mm
70×160 mm



R 136/11
3 mm
70×160 mm



R 660/12
90 mm
4 mm



**CSAK A KÉSZLET
EREJÉIG!**
R 140/6
0,5 mm
18×15 mm



R 710/1
122×46 mm



R 710/3
100×39 mm



R 662/1
105×220 mm
16×8 mm



R 662/2
105×220 mm
16×8 mm

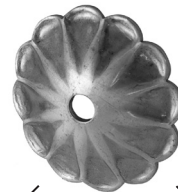

R 697/1
90 mm
3 mm



R 138/8
28×60 mm
0,5 mm



R 710/9
100×40 mm



R 710/13
100×28 mm

R 697/2
60 mm
3 mm

R 138/9
35×70 mm
0,5 mm

R 138/10
45×85 mm
0,5 mm



RF 9330
2 mm
90×10 mm



RF 9329
3 mm
90 mm



RF 9328
4 mm
60×60 mm



R 689/5
12 mm
120×220 mm



R 689/6
12 mm
120×220 mm



R 692/8
4 mm
100×330 mm



R 692/9
4 mm
50×180 mm



R 40/B/12
 \sphericalangle 2 mm
 \varnothing 48 mm



R 138/3
 \sphericalangle 2 mm
 \varnothing 88×17 mm



R 138/4
 \sphericalangle 2 mm
 \varnothing 90×10 mm



R 138/5
 \sphericalangle 0,3 mm
 \varnothing 90×15 mm



R 138/6
 \sphericalangle 0,3 mm
 \varnothing 50×10 mm



R 664/5
 \sphericalangle 3 mm
 \varnothing 90 mm



R 138/13
 \sphericalangle 0,5 mm
 190×195 mm



R 675/8
 \sphericalangle 3 mm
 60×85 mm



R 675/9
 \sphericalangle 3 mm
 60×85 mm



R 675/10
 \sphericalangle 3 mm
 80×110 mm



R 675/11
 \sphericalangle 3 mm
 85×110 mm



R 702/1
 \sphericalangle 0,5 mm
 62×110 mm



R 709/9 \sphericalangle 0,3 mm 54×56 mm
R 709/11 \sphericalangle 0,3 mm 72×72 mm



R 702/2
 \sphericalangle 0,5 mm
 52×65 mm



R 702/3
 \sphericalangle 0,5 mm
 80×200 mm



R 94/B/6
 \sphericalangle 4 mm
 \varnothing 115 mm



R 116/A/3
 \sphericalangle 3 mm
 \varnothing 95 mm



R 116/A/4
 \sphericalangle 3 mm
 \varnothing 65 mm

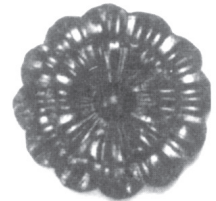

R 116/A/5
 \varnothing 95 mm



R 138/11
 \sphericalangle 0,5 mm
 75×70 mm



R 138/12
 \sphericalangle 0,5 mm
 95×105 mm

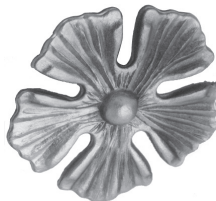

R 138/14
 \sphericalangle 4 mm
 \varnothing 120 mm



R 138/15
 \sphericalangle 2 mm
 \varnothing 60 mm



R 654/5
 \sphericalangle 6 mm
 \varnothing 60 mm



R 665/1 \sphericalangle 4 mm,
 \varnothing 130 mm
R 665/2 \sphericalangle 4 mm,
 \varnothing 140 mm



R 665/4 \sphericalangle 2 mm,
 \varnothing 90 mm
R 665/6 \sphericalangle 4 mm,
 \varnothing 80 mm



R 697/3 \sphericalangle 3 mm,
 \varnothing 95 mm
R 697/4 \sphericalangle 3 mm,
 \varnothing 65 mm



R 676/2 \varnothing 8×20 mm,
 \varnothing 50 mm
R 676/3 \varnothing 8×20 mm,
 \varnothing 70 mm



R 94/B/11
 \sphericalangle 4 mm
 180×130 mm



R 94/B/12
 \sphericalangle 4 mm
 180×130 mm



R 711/1
 ▧ 1 mm
 H 15 mm
 Ø 85 mm
R 711/2
 ▧ 1 mm
 H 10 mm
 Ø 68 mm



R 711/8
 ▧ 1 mm
 Ø 97 mm
 H 19 mm
R 711/9
 ▧ 1 mm
 Ø 120 mm
 H 26 mm



R 709/13
 ▧ 0,3 mm
 18×68 mm



R 711/7
 ▧ 1 mm
 Ø 140×25 mm

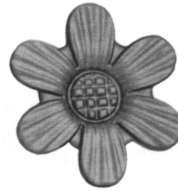

R 126/3
 ▧ 4 mm
 Ø 80 mm



R 695/4
 ▧ 4 mm
 60×60 mm



R 711/4
 ▧ 0,3 mm
 Ø 120×45 mm

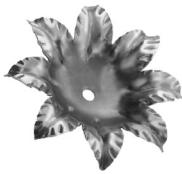

R 711/6
 ▧ 0,3 mm
 Ø 150×28 mm



R 705/11
 Ø 45×12 mm



R 661/1
 ▧ 16×8 mm
 140×155 mm



R 661/2
 ▧ 16×8 mm
 140×155 mm



R 94/B/9
 ▧ 4 mm
 120×85 mm



R 94/B/10
 ▧ 4 mm
 120×85 mm



R 1393/8 **R 1393/9**
 Ø 90 mm Ø 55 mm



R 756/14
 Ø 75 mm



R 662/3
 ▧ 4 mm
 65×130 mm



R 662/4
 ▧ 4 mm
 65×130 mm



R 666/2
 55×90 mm
 ▧ 4 mm



R 139/6
 28×70 mm
 ▧ 0,5 mm

CSAK A KÉSZLET
EREJÉIG!



R 756/2
 Ø 80 mm



R 756/4
 Ø 100 mm



R 663/1
 ▧ 16×6 mm
 110×140 mm



R 663/2
 ▧ 16×6 mm
 110×140 mm



R 656/B/9
 ▧ 2 mm
 85×75 mm



R 656/B/10
 ▧ 2 mm
 85×75 mm



R 710/7
 Ø 90×45 mm



R 656/B/7
 ▧ 2 mm
 50×125 mm



R 656/B/8
 ▧ 2 mm
 50×125 mm



R 137/1
 80×160 mm
 ▧ 1 mm



R 137/2
 80×160 mm
 ▧ 1 mm



R 663/5
 115×180 mm
 Ø 12 mm



R 663/6
 115×180 mm
 Ø 12 mm



R 705/13
 Ø 45×10 mm



R 126/1
□ 10 mm
H 140 mm



R 126/8
∅ 20 mm
60×115 mm



**CSAK A KÉSZLET
EREJÉIG!**
R 126/C/9
∅ 40 mm
80×150 mm



R 126/B/6
∅ 20 mm
45×80 mm



R 750/1
∅ 14 mm
H 150 mm



R 735/1
□ 14 mm
70×140 mm



R 735/2
□ 14 mm
20×115 mm



R 727/9
□ 25 mm
70×120 mm



R 126/C/8
□ 12 mm
H 100 mm



R 1385/1
□ 12 mm
30×150 mm



R 128/D/7
□ 12 mm
H 220 mm



R 129/8
□ 12 mm
H 200 mm



R 129/12
□ 12 mm
H 200 mm



R 126/B/4
∅ 20 mm
70×130 mm



R 124/1
∅ 12 mm
60×125 mm
R 124/2
∅ 15 mm
H 160 mm
**CSAK A KÉSZLET
EREJÉIG!**
R 124/9
∅ 20 mm
H 190 mm



R 124/3
∅ 12 mm
H 125 mm
**CSAK A KÉSZLET
EREJÉIG!**
R 124/5
∅ 20 mm
H 190 mm



R 126/2
□ 20 mm,
H 130 mm
R 126/15
□ 30 mm,
H 160 mm
R 126/16
□ 40 mm,
H 190 mm



R 731/5
□ 12 mm
23×110 mm

R 731/6
□ 16 mm
25×110 mm



R 126/19
∅ 25 mm
H 140 mm



R 732/1
□ 12 mm
25×135 mm



R 727/6
∅ 24 mm
60×160 mm



R 733/3
□ 12 mm
23×110 mm

R 733/4
□ 16 mm
25×110 mm



R 1855/4
∅ 12 mm
135×60 mm



R 1855/5
∅ 12 mm
135×60 mm



R 125/1
∅ 35 mm
H 140 mm



R 125/2
□ 14 mm
H 140 mm

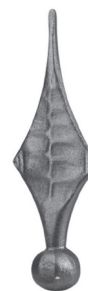

R 1855/10
∅ 30 mm
H 170 mm



R 1855/6
∅ 26 mm
48×150 mm

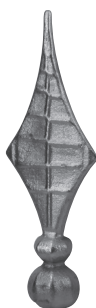

**CSAK A KÉSZLET
EREJÉIG!**
R 1855/8
∅ 40 mm
220 mm



R 727/11
∅ 30 mm
35×120 mm



R 124/7
∅ 14 mm
H 127 mm



**CSAK A KÉSZLET
EREJÉIG!**
R 120/3/SC
∅ 30 mm
H 165 mm

**NEM ÖNTÖTT!
KOVÁCSOLT!**



**CSAK A KÉSZLET
EREJÉIG!**

R 727/1
∅ 32 mm
70×140 mm

R 727/3
∅ 25 mm
55×110 mm



**CSAK A KÉSZLET
EREJÉIG!**

R 126/B/1
∅ 19 mm
82×195 mm
R 126/B/2
∅ 16 mm
68×160 mm

R 126/B/3
∅ 13 mm
54×130 mm



R 126/9
∅ 20 mm
H 90 mm

R 726/4
∅ 24 mm
H 125 mm



RF 9203
 □ 80×80 mm
 H 175 mm



RF 9202
 □ 100×100 mm
 H 190 mm



RF 9212
 □ 100×100 mm
 H 180 mm



R 1766/42
 □ 30 mm
 H 300 mm



RF 9215
 □ 80×80 mm
 H 80 mm



R 178/22
 □ 30 mm

R 178/30
 □ 40 mm



RF 9204
 □ 40×40 mm
 H 45 mm

RF 9205
 □ 50×50 mm
 H 55 mm

RF 9206
 □ 60×60 mm
 H 65 mm

RF 9207
 □ 80×80 mm
 H 90 mm

RF 9208
 □ 100×100 mm
 H 100 mm

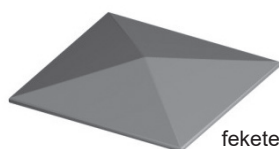

fekete

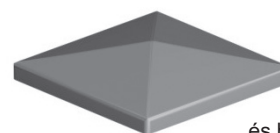

peremezett
és horganyzott

Rendelési szám	Mérete
R438	40×40 mm
R439	50×50 mm
R138.1	60×60 mm
R139	80×80 mm
R140	100×100 mm
R141	120×120 mm

Rendelési szám	Mérete
R185/Z/cink	30×30 mm
R186/Z/cink	40×40 mm
R187/Z/cink	50×50 mm
R188/Z/cink	60×60 mm
R189/Z/cink	80×80 mm
R190/Z/cink	100×100 mm

SZÁLLÍTÁSI HATÁRIDŐ: RENDELÉSTŐL SZÁMÍTVA 2 HÉT!



RF 9401
 □ 12×12 mm
 H 1140 mm

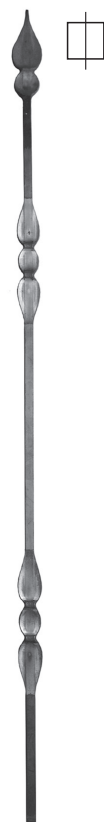

RF 9401/1
 □ 12×12 mm
 H 1140 mm



RF 9402
 □ 12×12 mm
 H 1070 mm



RF 9405
 □ 12×12 mm
 H 1140 mm



RF 9407
 □ 12×12 mm
 H 1140 mm



RF 9214
 ▧ 12×6 mm
 Hossz: 430 mm



RF 9219
 ▧ 12×6 mm
 Hossz: 540 mm



RF 9220
 □ 12 mm
 Hossz: 445 mm



RF 9213
 ▧ 12×6 mm
 Hossz: 740 mm



RF 9221
 ∅ 12 mm
 Hossz: 410 mm



- R 227/29 Aranypatina
- R 227/30 Rézpatina
- R 227/31 Zöldpatina
- R 227/32 Ezüstpatina
- R 227/50 Zöld rézpatina
- R 227/51 Fakó aranypatina
- R 227/52 Antik aranypatina



R 41/21
 Ø 6×40 mm
 feje: Ø 8 mm



R 41/12
 Ø 8×25 mm
 feje: Ø 17 mm



R 41/10
 Ø 6×40 mm
 feje: Ø 12 mm



R 185/9
 Horganspray

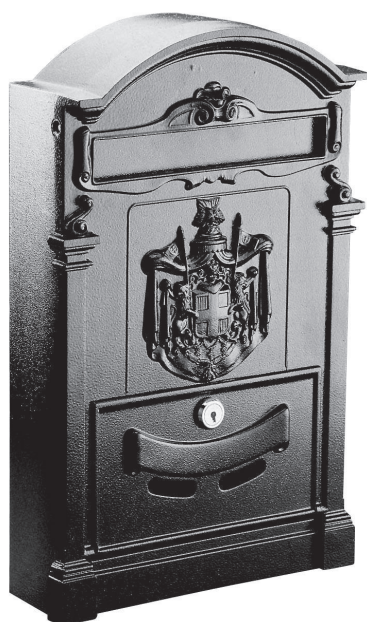

R 849/2
 255×90×405 mm

Alumínium postaláda
 fekete színű





R 181/10
 \square 30 mm
 105×280 mm

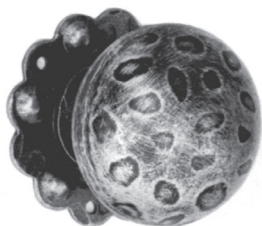

R 169/2
 \varnothing 60 mm

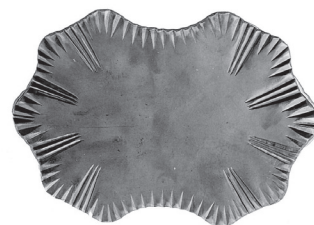

R 841/5
 \square 4 mm
 210×290 mm



R 169/11
 125×70 mm



R 169/12
 135×70 mm



R 169/14
 135×70 mm



R 169/15
 110×40 mm



R 170/1
 \varnothing 65 mm



R 170/2
 \varnothing 65 mm



R 170/3
 \varnothing 50 mm



R 170/5
 \varnothing 50 mm

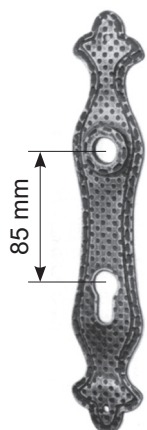

85 mm

R 169/8
 265×48 mm

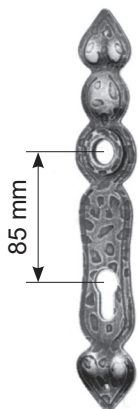

85 mm

R 169/9
 265×48 mm



R 169/10
 250×38 mm

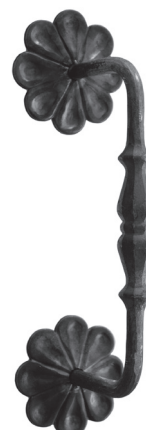

RF 9301
 90×320 mm



R 851/1-2-3-4-5-6-7-8-9-10
80×40×3 mm



R 171/1-2-3-4-5-6-7-8-9-10
H 120 mm



RF 9339/B 700×420×4 mm balos
RF 9339/J 700×420×4 mm jobbos
RF 9337/B 470×280×4 mm balos
RF 9337/J 470×280×4 mm jobbos

RF 9340 600×280×4 mm
RF 9338 400×185×4 mm



Levélbedobó

RF 9343
385x110 mm



Levélbedobó

RF 9344
280x135 mm



RF 9333
40×80×2 mm



RF 9334
40×80×2 mm



RF 9331
40×80×2 mm



RF 9332
40×80×2 mm

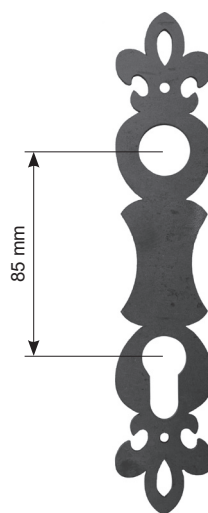

RF 9335
40×205×2 mm

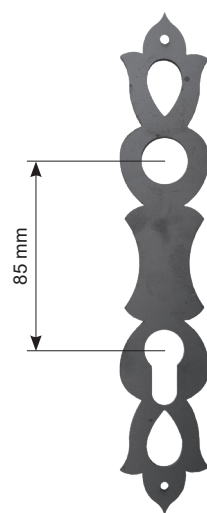

RF 9336
40×225×2 mm



R 158/1

14×4×4000 mm



R 158/3

14×4×4000 mm



R 158/5

11×3×4000 mm



R 1839/25

16×3×4000 mm

R 158/2

18×6×4000 mm

R 158/4

18×5×4000 mm

R 158/6

14×4×4000 mm

R 158/49

25×8×3000 mm

R 158/50

30×8×3000 mm

R 158/51

40×8×300 mm

RF 9304

1db 12×12 mm-es

14×4 mm-es

RF 9304/1

1db 14×14 mm-es

14×4 mm-es

RF 9304/2

1 db 12×12+1 db 12×6 mm-es

14×4 mm-es

RF 9304/3

1 db 12×12+2 db 12×6 mm-es

14×4 mm-es

RF 9304/4

1 db 20×20 mm-es

18×6 mm-es

RF 9304/5

1 db 25×25 mm-es

18×6 mm-es

RF 9304/6

1 db 30×30 mm-es

18×6 mm-es



RF 9304/7

1 db 12×12 mm-es

14×4 mm-es

RF 9304/8

1 db 14×14 mm-es

14×4 mm-es

RF 9304/9

1db 12×12+1db 12×6 mm-es

14×4 mm-es

RF 9304/10

1db 12×12+2 db 12×6 mm-es

14×4 mm-es

RF 9304/11

1 db 20×20 mm-es

18×5 mm-es

RF 9304/12

1 db 25×25 mm-es

18×5 mm-es

RF 9304/13

1 db 30×30 mm-es

18×5 mm-es



Élbordázott
laposacél



R 118/7
20×8×3000 mm

RR 1838/5/6
25×5×6000 mm

RR 1838/7/6
30×6×6000 mm

R 114/9/6
30×8×6000 mm

RR 114/81/6
40×6×6000 mm

R 1838/2/6
40×8×6000 mm

R 1838/3
50×8×3000 mm

Élbordázott
négyzetacél



R 118/1
12×3000 mm

R 118/1/6
12×6000 mm

R 118/2
14×3000 mm

R 118/2/6
14×6000 mm

Él- és lapbordázott
négyzetacél

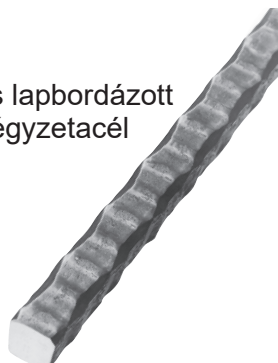

R 118/A/1
12×3000 mm

Nútot
négyzetacél



R 625/3
12×3000 mm

Élbordázott
zártszelvény



RR 118/E/1
16×1,5×6000 mm

RR 118/E/2
20×2,5×6000 mm

RR 118/E/9
25×2,5×6000 mm

RR 118/E/3
30×2,5×6000 mm

RR 118/E/5
40×2,5×6000 mm

RR 1374/15
50×2,5×6000 mm

RR 1374/17
60×2,5×6000 mm

R 1374/16
80×2,7×6000 mm

Élbordázott
és lapcsíkozott
laposacél



R 1839/11
30×6×3000 mm

R 1839/13
40×6×3000 mm

Él- és lapbordázott
laposacél



R 118/A/6
30×8×3000 mm

Élbordázott
zártszelvény

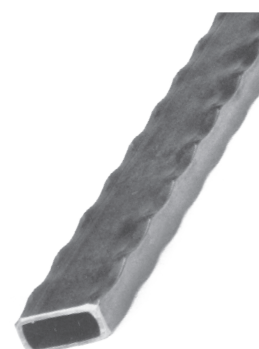

R 118/E/4
40×20×2,5×6000 mm

R 118/E/8
80×40×2,7×6000 mm

RR 118/E/7
60×40×2,5×6000 mm

Megmun-
kálatlan
laposacél



R 1368/12

☒ 12×6×3000 mm

R 1368/41

☒ 14×6×3000 mm

R 1368/13

☒ 14×8×3000 mm



R 623/1

☒ 12×6×3000 mm

R 623/3

☒ 14×6×3000 mm

Élmintás laposacél



R 1839/21

☒ 12×6×3000 mm

R 1839/22

☒ 14×6×3000 mm

Élbordázott laposacél



R 114/A/5

☒ 30×5×3000 mm





- R 599/1**
Ø 8×3000 mm
- R 599/2**
Ø 10×3000 mm
- R 599/3**
Ø 12×3000 mm
- R 599/4**
Ø 14×3000 mm
- R 599/9**
Ø 24×3000 mm



- R 1360/6**
Ø 12×2000 mm
furat: Ø 12×120 mm
 - R 42/A/1**
Ø 14×2000 mm
furat: Ø 14×100 mm
- Lyukasztott köracél



- R 1360/1**
□ 12×2000 mm
furat: □ 12×120 mm
- R 1360/2**
□ 14×2000 mm
furat: □ 14×140 mm

Élmángorolt
lyukasztott
négyzetacél



- R 1360/7**
□ 12×2000 mm
furat: □ 12×120 mm
- R 42/A/5**
□ 14×2000 mm
furat: □ 14×110 mm

Lyukasztott
négyzetacél



R 1834/1
 ∇ 32×5×3000 mm



R 1834/2
 ∇ 31×5×3000 mm



R 1834/3
 ∇ 31×5×3000 mm



R 1834/4
 ∇ 31×5×3000 mm



R 1834/6
 ∇ 31×9×3000 mm



R 1834/9
 ∇ 32×6×3000 mm



R 1838/8
 ∇ 30×5×3000 mm

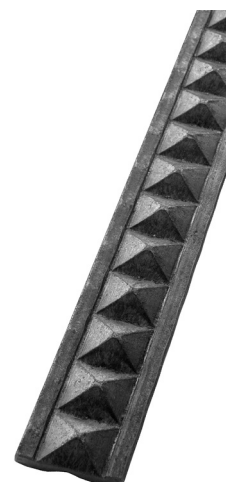

R 1834/5
 ∇ 32×9×3000 mm



R 180/49
 ∇ 40×6×2500 mm



R 114/5
 □ 40×8×3000 mm



R 114/12
 □ 40×8×3000 mm



R 1837/6
 □ 30×6×3000 mm



R 114/10
 □ 40×8×3000 mm



R 810/B/1/T
 □ 35×9×3000 mm

R 114/5/6
 □ 40×8×6000 mm

R 114/12/6
 □ 40×8×6000 mm

R 114/A/1
 □ 43×7×3750 mm

R 114/10/6
 □ 40×8×6000 mm



R 114/A/3
 □ 50×14×3000 mm



R 1373/4
 □ 40×11×3000 mm



R 811/4/T
 □ 41×11×3000 mm



R 811/5/T
 □ 50×14×3000 mm



R 158/10/C
 △ 30×8×3000 mm

R 114/A/3/6
 □ 50×14×6000 mm

R 811/7/T
 □ 41×11×6000 mm

R 158/12/C
 △ 40×11×3000 mm

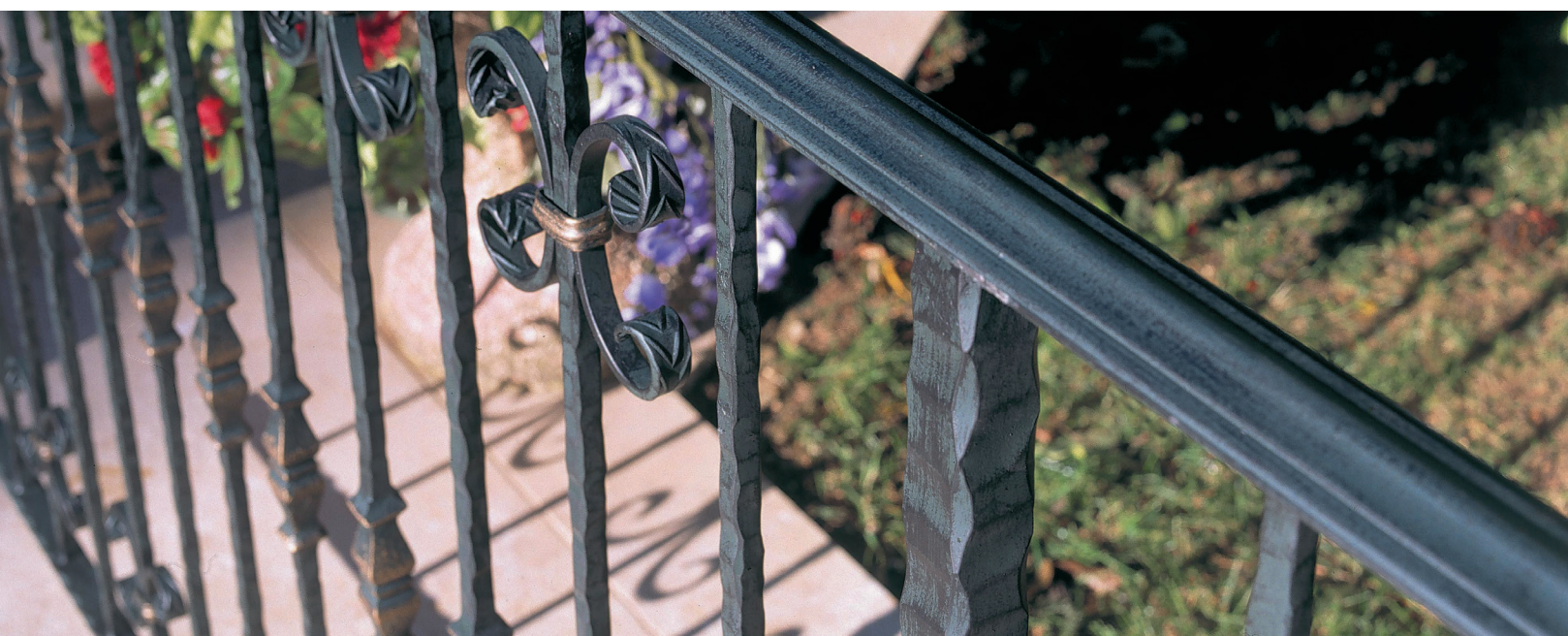

Korlátetű rögzítő elemek, oldalfalra.



R 114/B/13
114/A/3-hez

R 116/10
114/5-höz

R 116/14
114/10-hez

R 116/16
114/12-höz

R 812/6
158/12/C-hez

R 812/13/T
811/4/T-hez

R 812/15/T
811/5/T-hez

R 1377/14/T
810/B/1/T-hez

R 1817/9
1373/4-hez

R 1818/11
114/9-hez

R 1818/12
1838/2-höz

R 1818/15
114/A/1-hez



R 114/B/14
114/A/3-hez

R 116/2
114/5-höz

R 116/6
114/10-hez

R 116/8
114/12-höz

R 812/2
158/12/C-hez

R 1377/41/T
811/4/T-hez

R 1377/42/T
811/5/T-hez

R 1377/1/T
810/B/1/T-hez

R 1817/5
1373/4-hez

R 1818/7
114/9-hez

R 1818/8
1838/2-höz

R 114/B/1
114/A/1-hez



RF 9302
90×170 mm

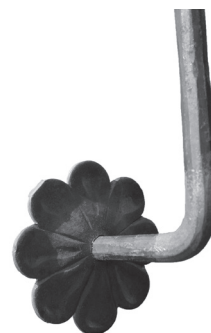

RF 9305
90×150 mm



RF 9303
90×230 mm



R 94/A/2
160×95 mm



R 1814/17
1373/4-hez

R 1814/18
114/A/3-hez



R 1814/11
1373/4-hez

R 1814/12
114/A/3-hez



R 1817/9/S5
1373/4-hez

R 114/B/13/S9
114/A/3-hez

• ROZSDAMENTES •

	Cikkszám	Méret
AISI 304	RE001/6000	Ø 42,4x2,0x6000 mm
	RFE001/1000	Ø 42,4x2,0x1000 mm
	RFE001/1200	Ø 42,4x2,0x1200 mm
	RFE001/1500	Ø 42,4x2,0x1500 mm
	RFE001/2000	Ø 42,4x2,0x2000 mm
	RFE001/3000	Ø 42,4x2,0x3000 mm
	RFE001/4000	Ø 42,4x2,0x4000 mm



	Cikkszám	Méret
AISI 304	RE005/6000	Ø 12,0x6000 mm
	RFE005/3000	Ø 12,0x3000 mm

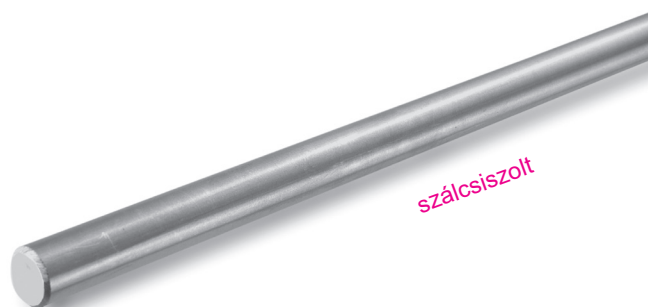

ÁLLÍTHATÓ SZÁRRAL



RE031/S1

Ø 42,4x2,0 mm-es
cső részére



RE510/424

Ø 42,4x2,0 mm-es
cső részére



RE0102

Ø 42,4x2,0 mm-es
cső részére



RE030/S

Ø 42,4x2,0 mm-es
cső részére

ÁLLÍTHATÓ SZÁRRAL



RE500/424

Ø 42,4x2,0 mm-es
cső részére



RE0104

Ø 42,4x2,0 mm-es
cső részére

AISI 303: csak vízzel és vízgőzzel szemben korrózióálló!

AISI 304: csak vízzel és vízgőzzel szemben korrózióálló!

AISI 316: vízzel, savval, lúggal, klórral és azok gőzeivel szemben korrózióálló!



Ragasztva



Gumival
kalapálva



Csavarozva



Hegesztve

• ROZSDAMENTES • SZÁLCSISZOLT •

Szög váltás térben

Szög váltás síkban



RE450/304

Ø 42,4x2,0 mm-es cső részére



RE451/304

Ø 42,4x2,0 mm-es cső részére



RE4483

Ø 42,4x2,0 mm-es cső részére



RE4471/304

Ø 42,4x2,0 mm-es cső részére



RE5587/304

Ø 42,4x2,0 mm-es cső részére



RE0696

Ø 42,4x2,0 mm-es cső részére



RE116200

Ø 42,4x2,0 mm-es cső részére



RE113

Ø 42,4x2,0 mm-es cső részére



RE0127

Ø 25 mm
zsákfurat Ø 12,2 mm



RE0069

Ø 42,4x2,0 mm-es cső részére
Furat: Ø 12,2 mm

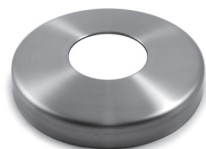

RE020

Ø 42,4x2,0 mm-es cső részére



RE0223

Ø 42,4x2,0 mm-es cső részére



RE036400

Ø 42,4x2,0 mm-es cső részére



RE4566

Ø 42,4x2,0 mm-es cső részére



RE4561

Ø 42,4x2,0 mm-es cső részére

90°-OS ALÁTÉT



RE011971

Ø 42,4x2,0 mm-es cső részére



RE481

Ø 42,4x2,0 mm-es cső részére



RE01112

Ø 42,4x2,0 mm-es cső részére



RE0119

Ø 42,4x2,0 mm-es cső részére

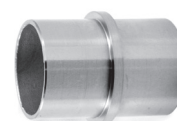

RE455/304

Ø 42,4x2,0 mm-es cső részére

• ROZSDAMENTES •

	Cikkszám	Méret
AISI 304	RE06204040	□ 40,0x40,0x2,0x6000 mm
	RFE062040/900	□ 40,0x40,0x2,0x900 mm
	RFE062040/1100	□ 40,0x40,0x2,0x1100 mm

	Cikkszám	Méret
AISI 304	RE005/6000	∅ 12,0x6000 mm
	RFE005/3000	∅ 12,0x3000 mm

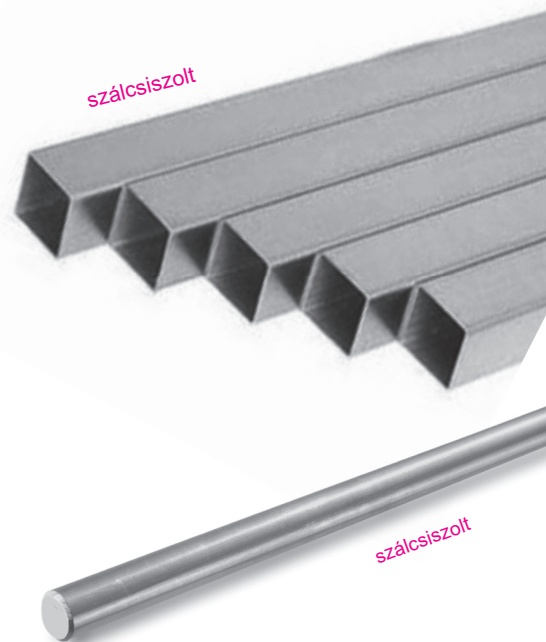

RE037600
□ 40,0x2,0 mm-es zártszelvényhez

RE037400
□ 40,0x2,0 mm-es zártszelvényhez

RE037200
□ 40,0x2,0 mm-es zártszelvényhez

RE037800
□ 40,0x2,0 mm-es zártszelvényhez

RE4230
□ 40,0x2,0 mm-es zártszelvényhez



RE011970
□ 40,0x2,0 mm-es zártszelvényhez



RE4713/304
□ 40,0x2,0 mm-es zártszelvényhez



RE4743
□ 40,0x2,0 mm-es zártszelvényhez

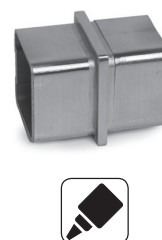

RE4760/304
□ 40,0x2,0 mm-es zártszelvényhez



RE02050
□ 40,0x2,0 mm-es zártszelvényhez



RE02052
□ 40,0x2,0 mm-es zártszelvényhez

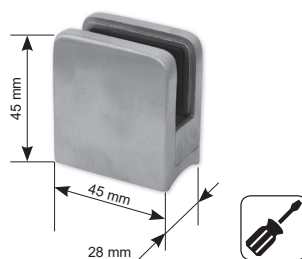

Cikkszám	Csatlakozás	Üveg méret
RE 1 11 000 08	zártszelvény	8 mm
RE 1 11 000 10	zártszelvény	10 mm

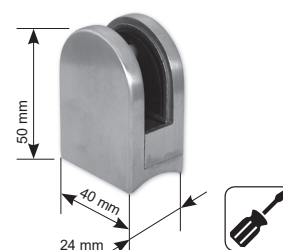

Cikkszám	Csatlakozás	Üveg méret
RE 1 10 042 08	∅ 42,4 mm cső	8 mm
RE 1 16 042 10	∅ 42,4 mm cső	10 mm

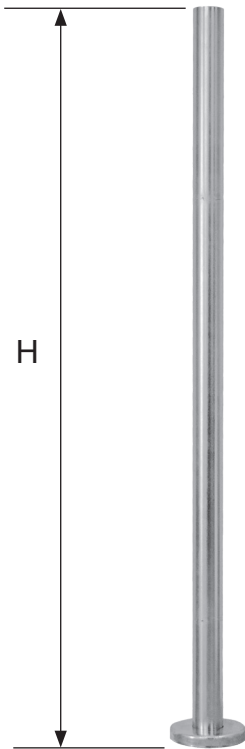

AISI 304	Cikkszám	Méret	H
	RFE0171	Ø 42,4 mm	1000 mm

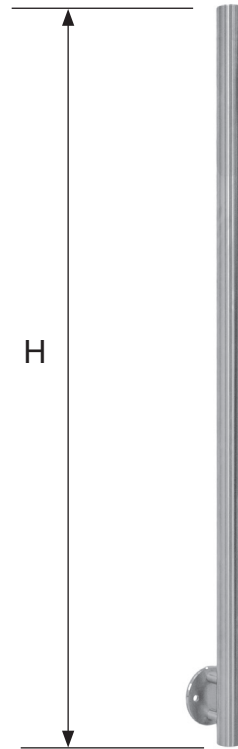

AISI 304	Cikkszám	Méret	H
	RFE0173	Ø 42,4 mm	1200 mm

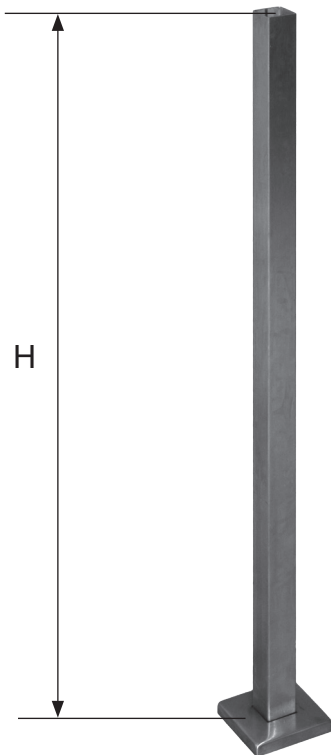

AISI 304	Cikkszám	Méret	H
	RFE0177	□ 40,0 mm	900 mm

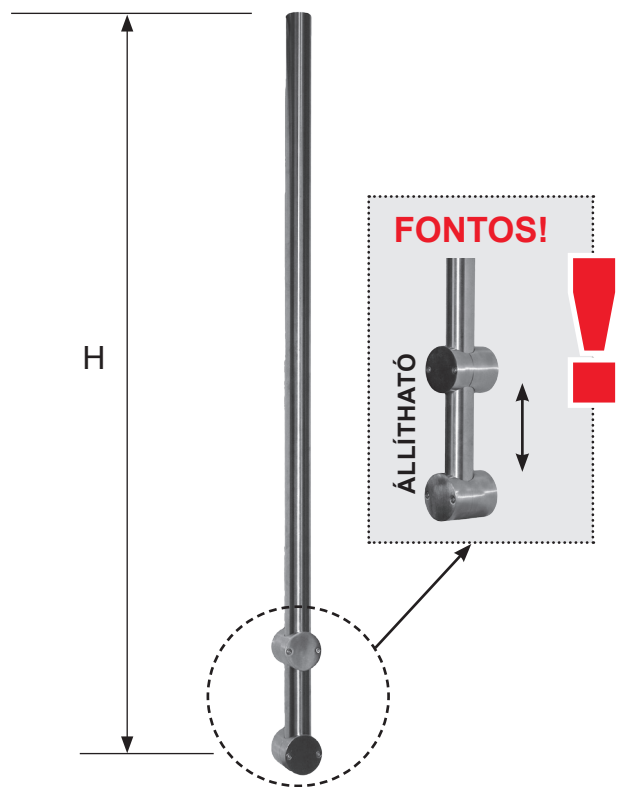

AISI 304	Cikkszám	Méret	H
	RFE0288	Ø 42,4 mm	1200 mm

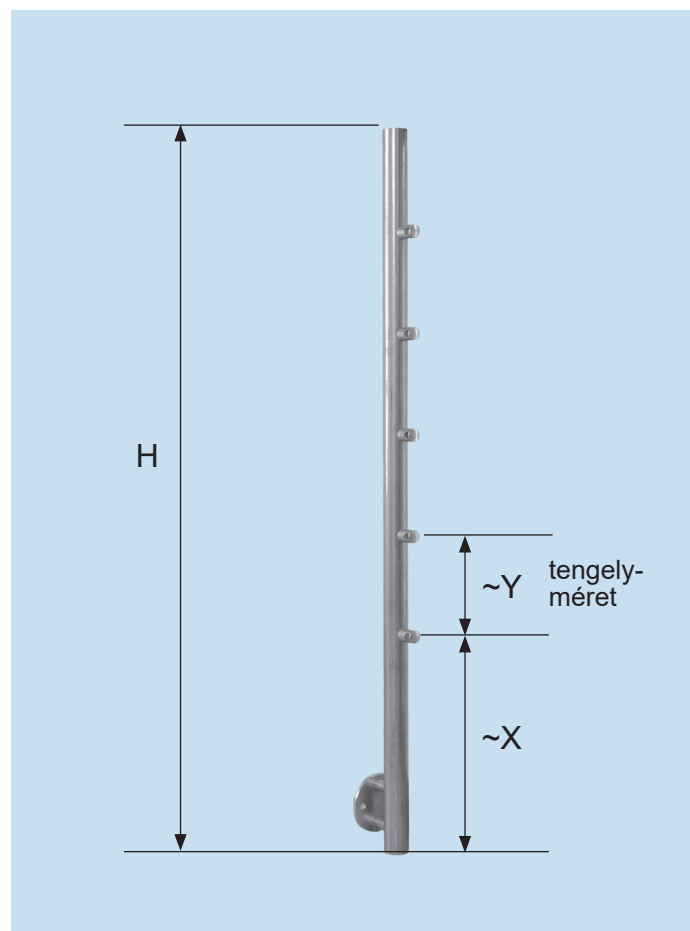
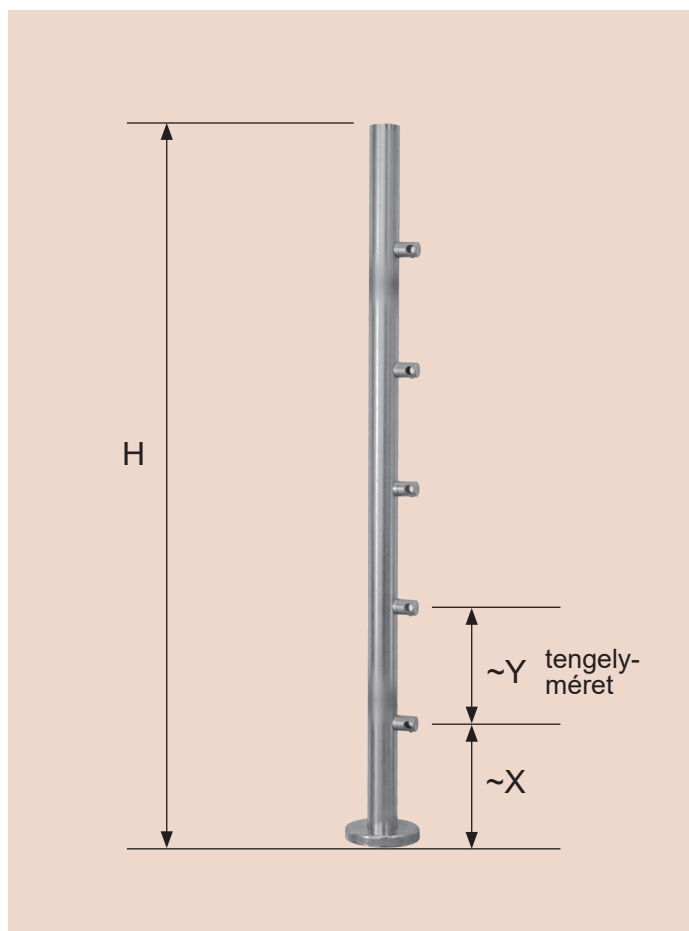

Cikkszám	Méret (mm)	H (mm)	X (mm)	Y (mm)	Vízszintes sorok száma	Párhuzamos szabadnyílás (mm)	Furatméret	Furatirány	Megj.
RFE0282	Ø 42,4	1000	~ 179	~ 179	5	~ 167	Ø 12,2 mm	átmenő	raktáron
RFE0282/J	Ø 42,4	1000	~ 179	~ 179	5	~ 167	Ø 12,2 mm	jobbos, zsákfurat	raktáron
RFE0282/B	Ø 42,4	1000	~ 179	~ 179	5	~ 167	Ø 12,2 mm	balos, zsákfurat	raktáron
RFE0300	Ø 42,4	1000	~ 154	~ 154	6	~ 142	Ø 12,2 mm	átmenő	rendelésre*
RFE0300/J	Ø 42,4	1000	~ 154	~ 154	6	~ 142	Ø 12,2 mm	jobbos, zsákfurat	rendelésre*
RFE0300/B	Ø 42,4	1000	~ 154	~ 154	6	~ 142	Ø 12,2 mm	balos, zsákfurat	rendelésre*
RFE0284	Ø 42,4	1200	~ 379	~ 179	5	~ 167	Ø 12,2 mm	átmenő	raktáron
RFE0284/J	Ø 42,4	1200	~ 379	~ 179	5	~ 167	Ø 12,2 mm	jobbos, zsákfurat	raktáron
RFE0284/B	Ø 42,4	1200	~ 379	~ 179	5	~ 167	Ø 12,2 mm	balos, zsákfurat	raktáron
RFE0306	Ø 42,4	1200	~ 354	~ 154	6	~ 142	Ø 12,2 mm	átmenő	rendelésre*
RFE0306/J	Ø 42,4	1200	~ 354	~ 154	6	~ 142	Ø 12,2 mm	jobbos, zsákfurat	rendelésre*
RFE0306/B	Ø 42,4	1200	~ 354	~ 154	6	~ 142	Ø 12,2 mm	balos, zsákfurat	rendelésre*

*Szállítási határidő a megrendeléstől számított 2 hét!

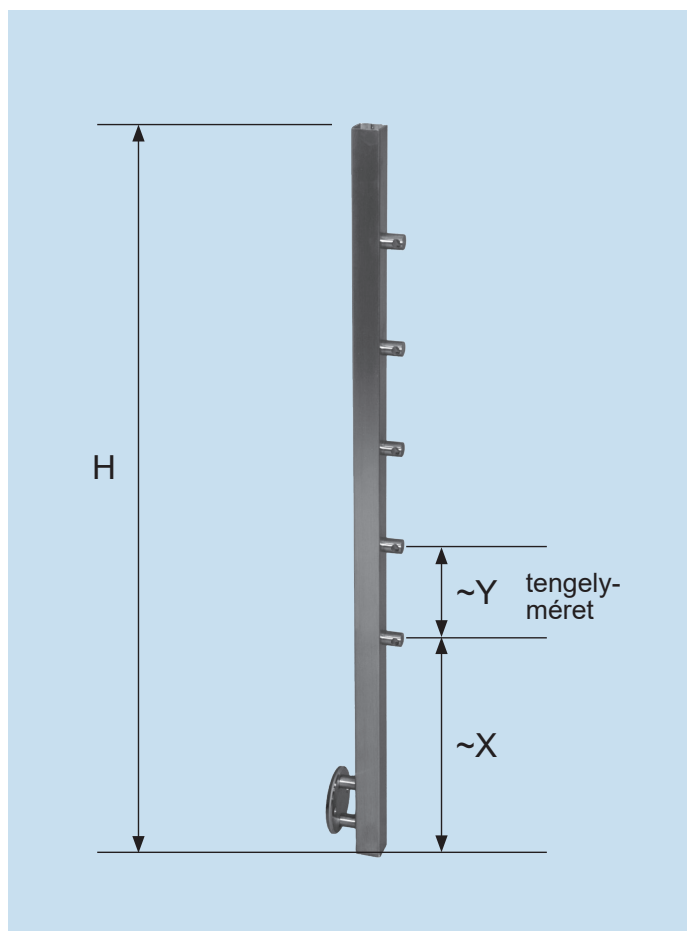
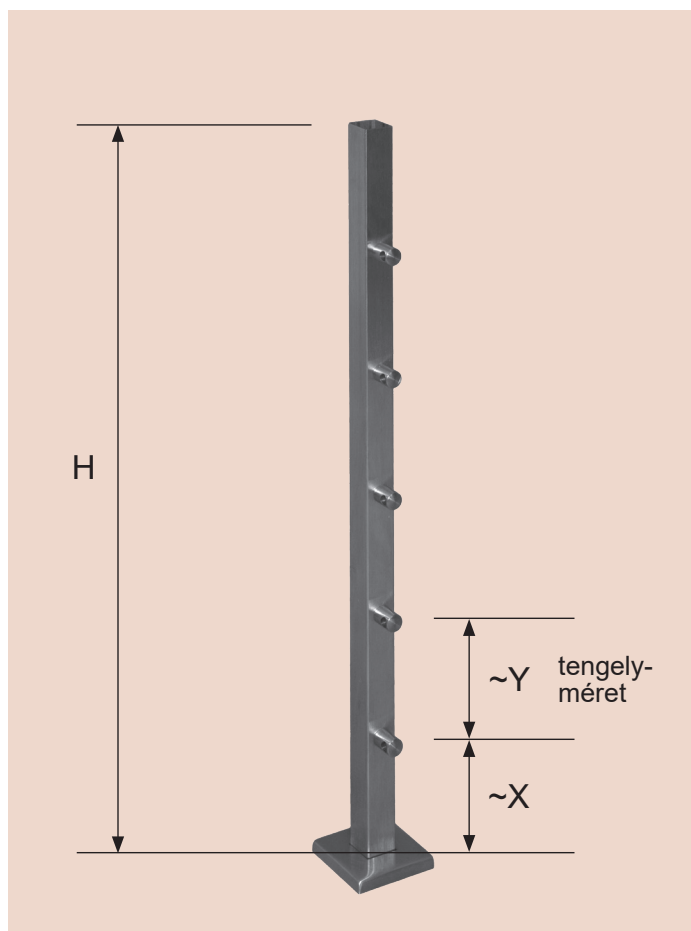

AISI 304	Cikkszám	Méret (mm)	H (mm)	X (mm)	Y (mm)	Vízszintes sorok száma	Párhuzamos szabadnyílás (mm)	Furatméret	Furatirány	Megj.
	RFE0272	□ 40,0	900	~ 163	~ 163	5	~ 155	Ø 12,2 mm	átmenő	raktáron
	RFE0272/J	□ 40,0	900	~ 163	~ 163	5	~ 155	Ø 12,2 mm	jobbos, zsákfurat	raktáron
	RFE0272/B	□ 40,0	900	~ 163	~ 163	5	~ 155	Ø 12,2 mm	balos, zsákfurat	raktáron
	RFE0304	□ 40,0	900	~ 122	~ 122	7	~ 110	Ø 12,2 mm	átmenő	rendelésre*
	RFE0304/J	□ 40,0	900	~ 122	~ 122	7	~ 110	Ø 12,2 mm	jobbos, zsákfurat	rendelésre*
	RFE0304/B	□ 40,0	900	~ 122	~ 122	7	~ 110	Ø 12,2 mm	balos, zsákfurat	rendelésre*
	RFE0274	□ 40,0	1105	~ 363	~ 163	5	~ 151	Ø 12,2 mm	átmenő	raktáron
	RFE0274/J	□ 40,0	1105	~ 363	~ 163	5	~ 151	Ø 12,2 mm	jobbos, zsákfurat	raktáron
	RFE0274/B	□ 40,0	1105	~ 363	~ 163	5	~ 151	Ø 12,2 mm	balos, zsákfurat	raktáron
RFE0308	□ 40,0	1105	~ 322	~ 122	7	~ 110	Ø 12,2 mm	átmenő	rendelésre*	
RFE0308/J	□ 40,0	1105	~ 322	~ 122	7	~ 110	Ø 12,2 mm	jobbos, zsákfurat	rendelésre*	
RFE0308/B	□ 40,0	1105	~ 322	~ 122	7	~ 110	Ø 12,2 mm	balos, zsákfurat	rendelésre*	

*Szállítási határidő a megrendeléstől számított 2 hét!

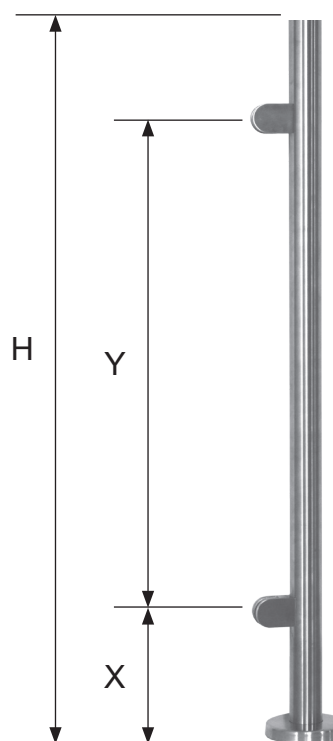
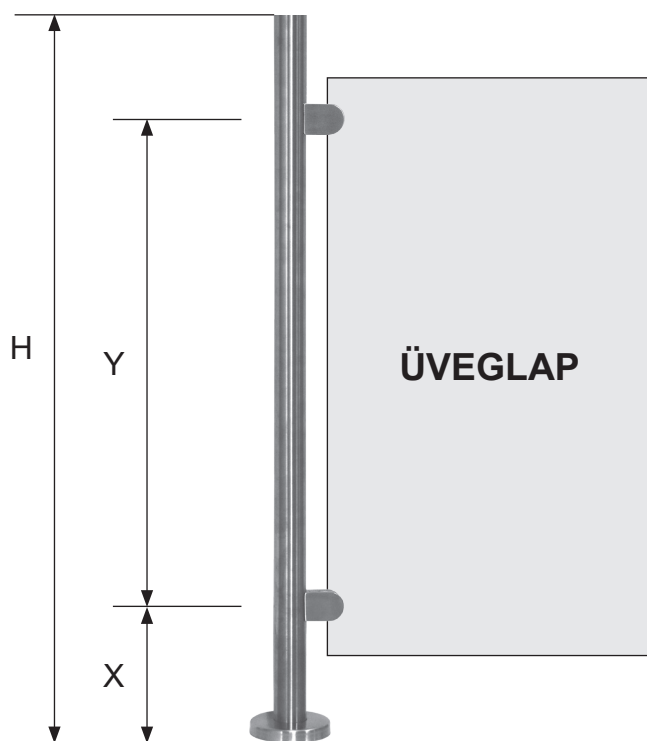

AISI 304	Cikkszám	Méret (mm)	H (mm)	X (mm)	Y (mm)
	RFE0192*	Ø 42,4	1000	100	800

AISI 304	Cikkszám	Méret (mm)	H (mm)	X (mm)	Y (mm)
	RFE0196*	Ø 42,4	1000	100	800

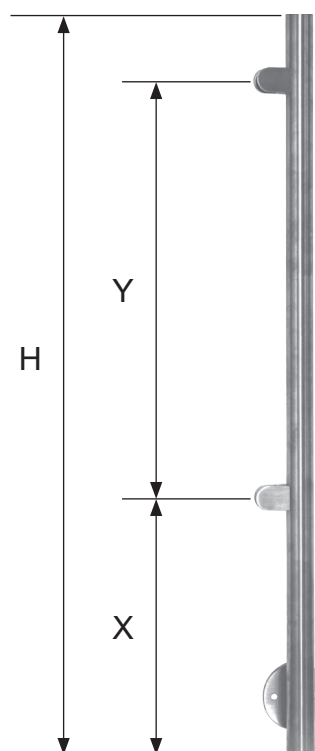
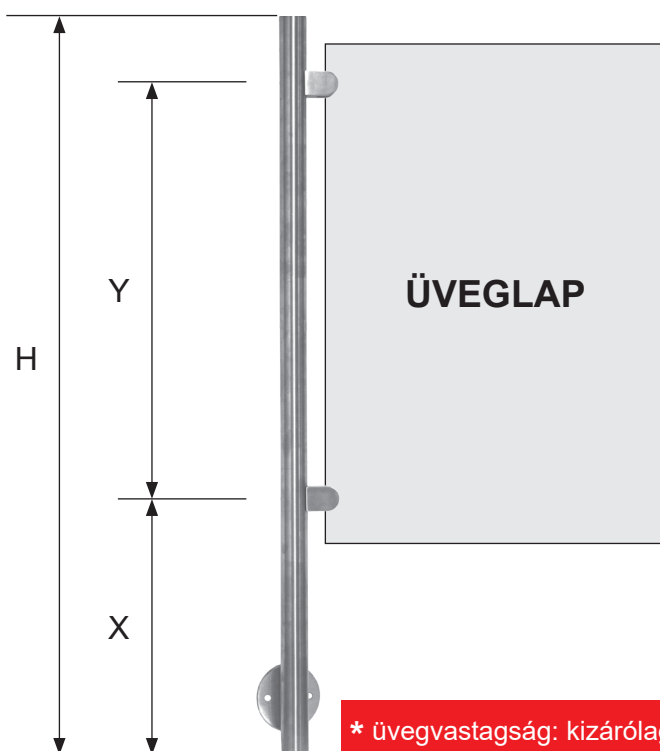

AISI 304	Cikkszám	Méret (mm)	H (mm)	X (mm)	Y (mm)
	RFE0182*	Ø 42,4	1200	300	800

AISI 304	Cikkszám	Méret (mm)	H (mm)	X (mm)	Y (mm)
	RFE0186*	Ø 42,4	1200	300	800

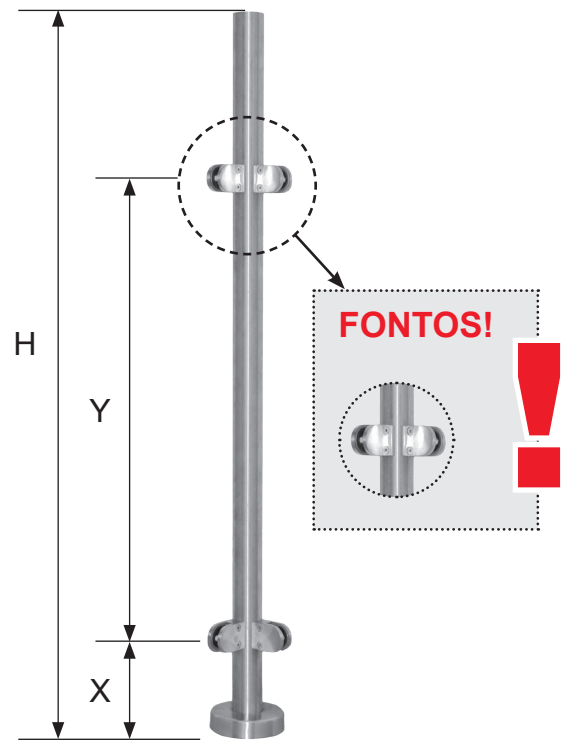
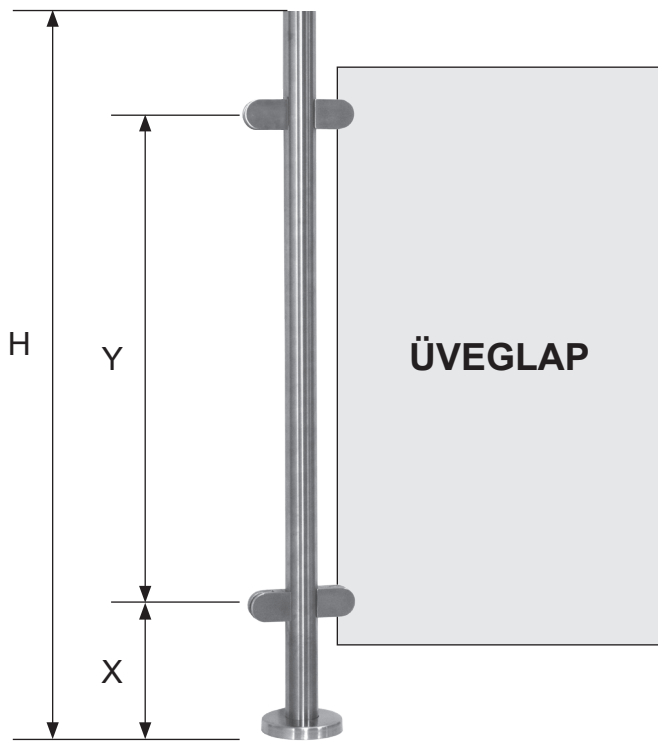

AISI 304	Cikkszám	Méret (mm)	H (mm)	X (mm)	Y (mm)
	RFE0194*	Ø 42,4	1000	100	800

AISI 304	Cikkszám	Méret (mm)	H (mm)	X (mm)	Y (mm)
	RFE0197*	Ø 42,4	1000	100	800

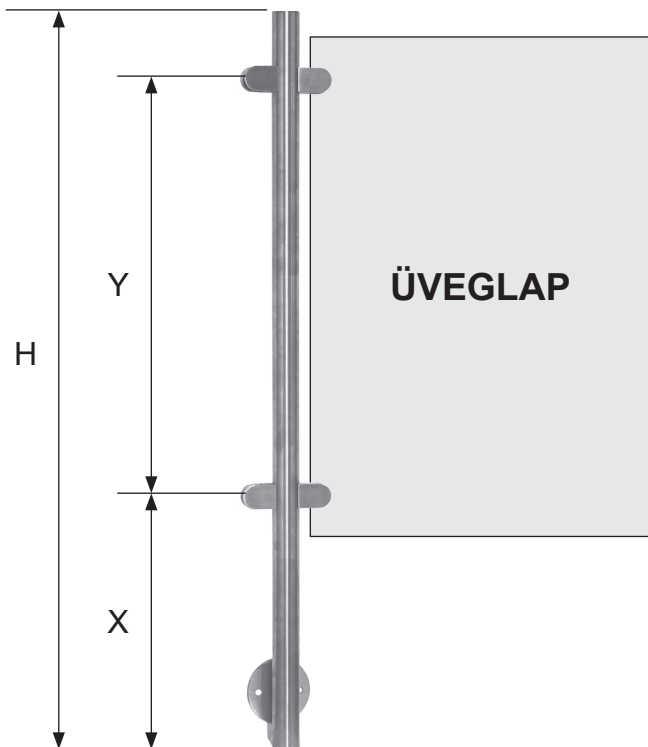

AISI 304	Cikkszám	Méret (mm)	H (mm)	X (mm)	Y (mm)
	RFE0184*	Ø 42,4	1200	300	800



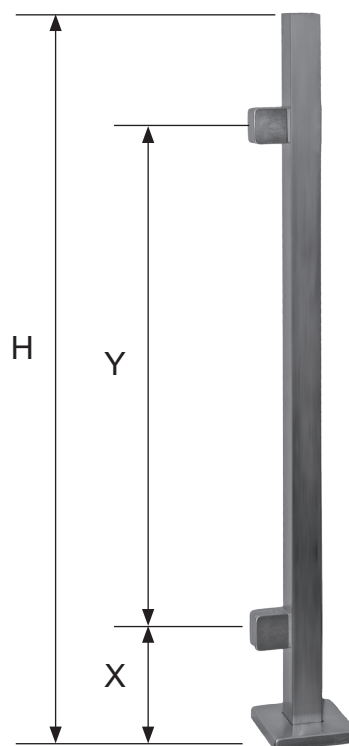
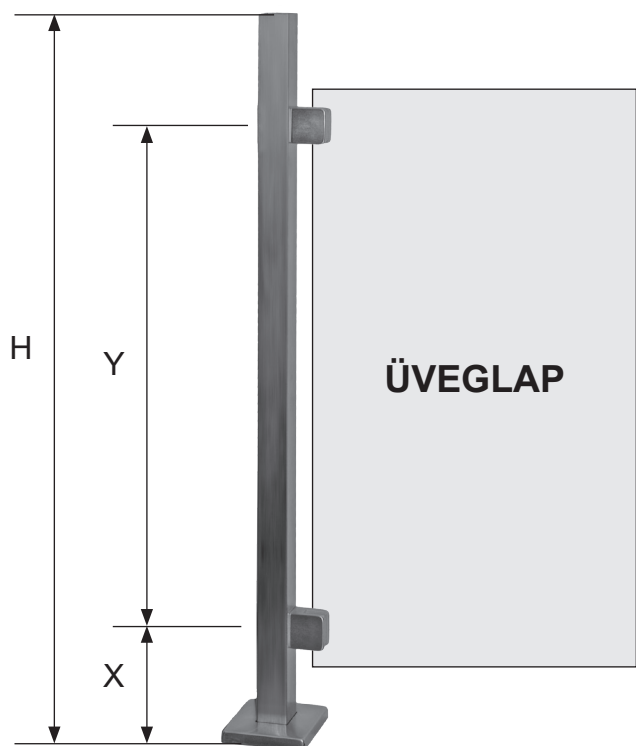

AISI 304	Cikkszám	Méret (mm)	H (mm)	X (mm)	Y (mm)
	RFE0277*	□ 40,0	900	100	700

AISI 304	Cikkszám	Méret (mm)	H (mm)	X (mm)	Y (mm)
	RFE0278*	□ 40,0	900	100	700

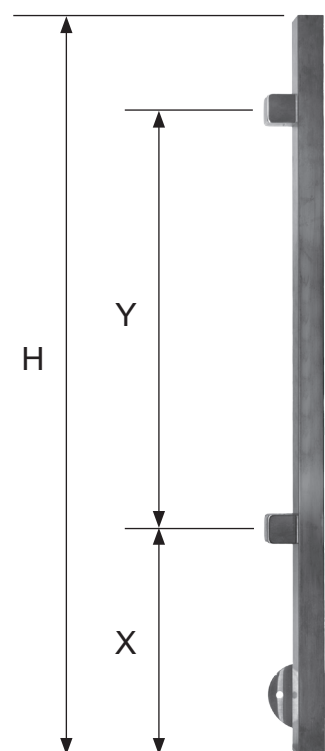
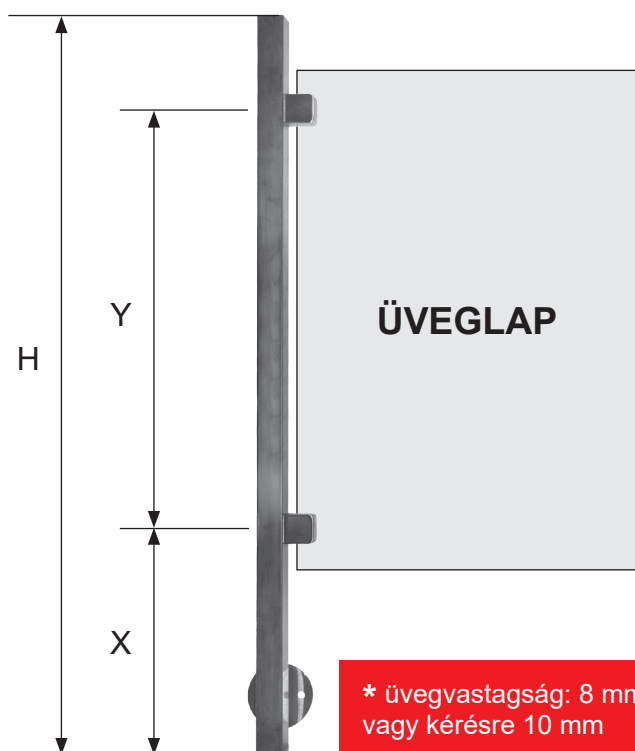

AISI 304	Cikkszám	Méret (mm)	H (mm)	X (mm)	Y (mm)
	RFE0285*	□ 40,0	1105	300	700

AISI 304	Cikkszám	Méret (mm)	H (mm)	X (mm)	Y (mm)
	RFE0286*	□ 40,0	1105	300	700

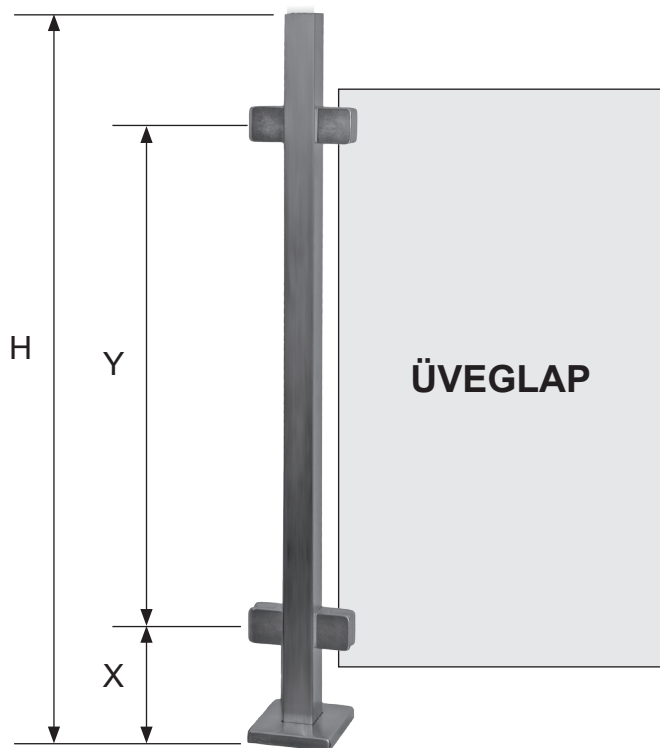

AISI 304	Cikkszám	Méret (mm)	H (mm)	X (mm)	Y (mm)
	RFE0279*	□ 40,0	900	100	700

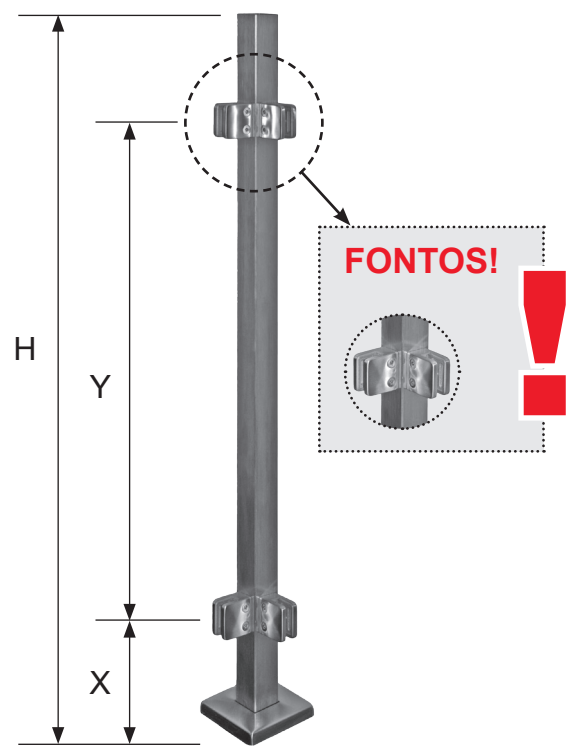

AISI 304	Cikkszám	Méret (mm)	H (mm)	X (mm)	Y (mm)
	RFE0280*	□ 40,0	900	100	700

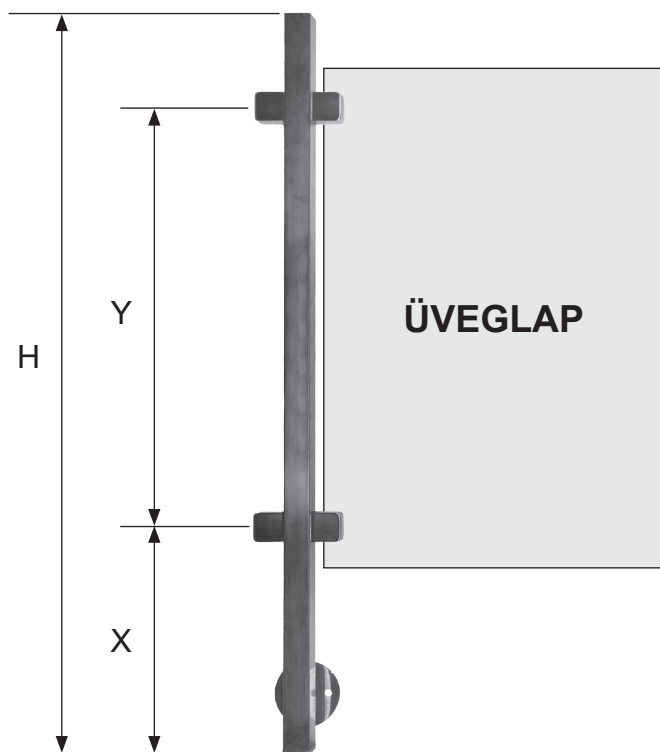



AISI 304	Cikkszám	Méret (mm)	H (mm)	X (mm)	Y (mm)
	RFE0287*	□ 40,0	1105	300	700

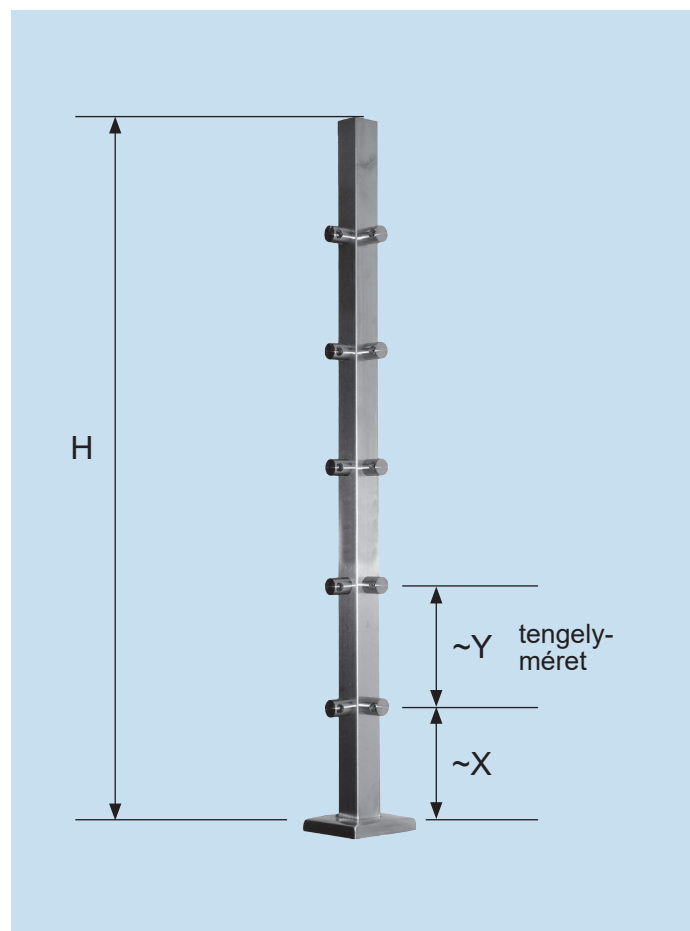
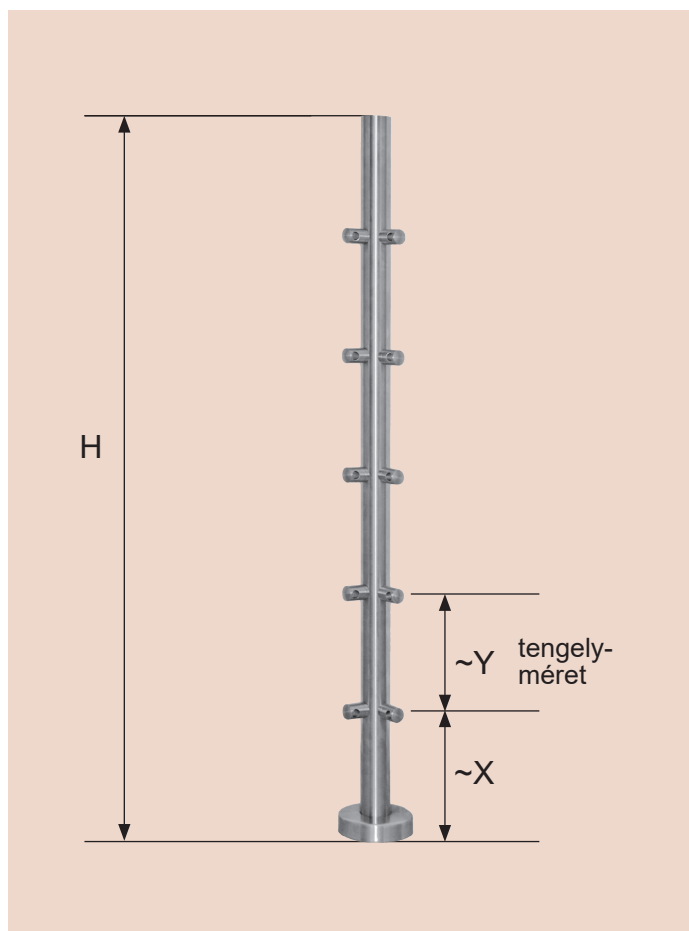





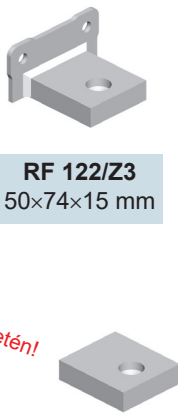

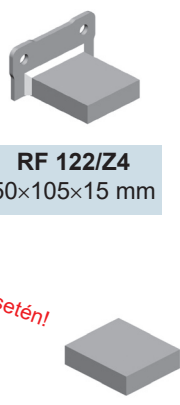
	Cikkszám	Méret (mm)	H (mm)	X (mm)	Y (mm)	Vízszintes sorok száma	Párhuzamos szabadnyílás (mm)	Furatméret	Furatirány	Megj.
AISI 304	RFE0292	Ø 42,4	1000	~ 179	~ 179	5	~ 167	Ø 12,2 mm	átmenő	raktáron
	RFE0292/J	Ø 42,4	1000	~ 179	~ 179	5	~ 167	Ø 12,2 mm	jobbos, zsákfurat	raktáron
	RFE0292/B	Ø 42,4	1000	~ 179	~ 179	5	~ 167	Ø 12,2 mm	balos, zsákfurat	raktáron
	RFE0302	Ø 42,4	1000	~ 154	~ 154	6	~ 142	Ø 12,2 mm	átmenő	rendelésre*
	RFE0302/J	Ø 42,4	1000	~ 154	~ 154	6	~ 142	Ø 12,2 mm	jobbos, zsákfurat	rendelésre*
	RFE0302/B	Ø 42,4	1000	~ 154	~ 154	6	~ 142	Ø 12,2 mm	balos, zsákfurat	rendelésre*
	RFE0276	□ 40,0	900	~ 163	~ 163	5	~ 151	Ø 12,2 mm	átmenő	raktáron
	RFE0276/J	□ 40,0	900	~ 163	~ 163	5	~ 151	Ø 12,2 mm	jobbos, zsákfurat	raktáron
	RFE0276/B	□ 40,0	900	~ 163	~ 163	5	~ 151	Ø 12,2 mm	balos, zsákfurat	raktáron
	RFE0305	□ 40,0	900	~ 122	~ 122	7	~ 110	Ø 12,2 mm	átmenő	rendelésre*
	RFE0305/J	□ 40,0	900	~ 122	~ 122	7	~ 110	Ø 12,2 mm	jobbos, zsákfurat	rendelésre*
	RFE0305/B	□ 40,0	900	~ 122	~ 122	7	~ 110	Ø 12,2 mm	balos, zsákfurat	rendelésre*

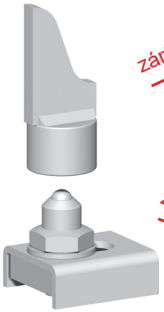
*Szállítási határidő a megrendeléstől számított 2 hét!

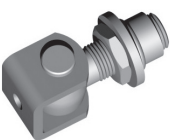
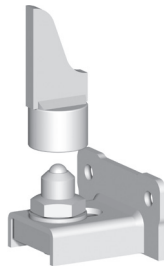
 <p>R 120 (fekete) 30×89×20 mm</p> <p>R 120/Z (galvanizált) 30×89×20 mm</p>	<p><i>falazott oszlop esetén!</i></p>  <p>RF 122/Z3 50×74×15 mm</p> <p>RF 122/Z1 50×65×15 mm</p> <p><i>zártszelvény oszlop esetén!</i></p>	 <p>R 285.40 Ø 40 mm</p>	<p><i>falazott oszlop esetén!</i></p>  <p>RF 122/Z4 50×105×15 mm</p> <p>RF 122/Z2 50×100×15 mm</p> <p><i>zártszelvény oszlop esetén!</i></p>
--	---	--	---

 <p>R 289.40 állítható alsó zsanér</p>	<p><i>zártszelvény oszlop esetén!</i></p>  <p>R 432C M 18</p> <p><i>zártszelvény oszlop esetén!</i></p>  <p>R 230.18C M 18</p>	 <p>R 289.40P állítható alsó zsanér</p>	<p><i>falazott oszlop esetén!</i></p>  <p>R 231B.18C M 18</p> <p><i>falazott oszlop esetén!</i></p>  <p>RF 9508 M18 □ 80×80×8 mm</p> <p>RF 9507 M18 □ 80×80×8 mm</p>
---	--	---	---

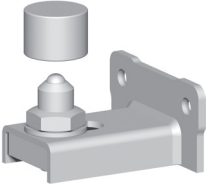
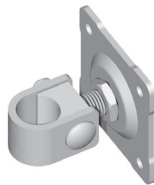
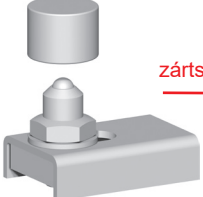
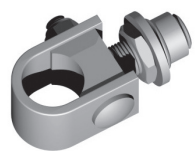
 <p>R 287.40P állítható alsó zsanér</p>	<p><i>falazott oszlop esetén!</i></p>  <p>R 241B.18 M 18</p>	 <p>R 287.40 állítható alsó zsanér</p>	<p><i>zártszelvény oszlop esetén!</i></p>  <p>R 240.18 M 18</p>
---	--	---	---

Csavarozható!

Betonozható!

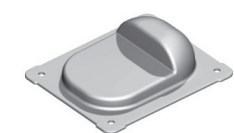

R 145F
Ütközési magasság:
20-35 mm

R 146F
Ütközési magasság:
25-40 mm



R 145
Ütközési felület
70 × 18 mm

R 146
Ütközési felület
90 × 21 mm

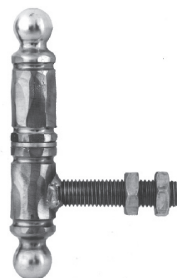

R 181/14
Ø 30×230 mm



RF 9341
Ø 25×160 mm



RF 9342
Ø 18×110 mm

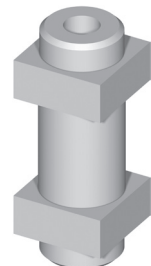

RF 247.18F
35×35 mm

RKC 7101.160

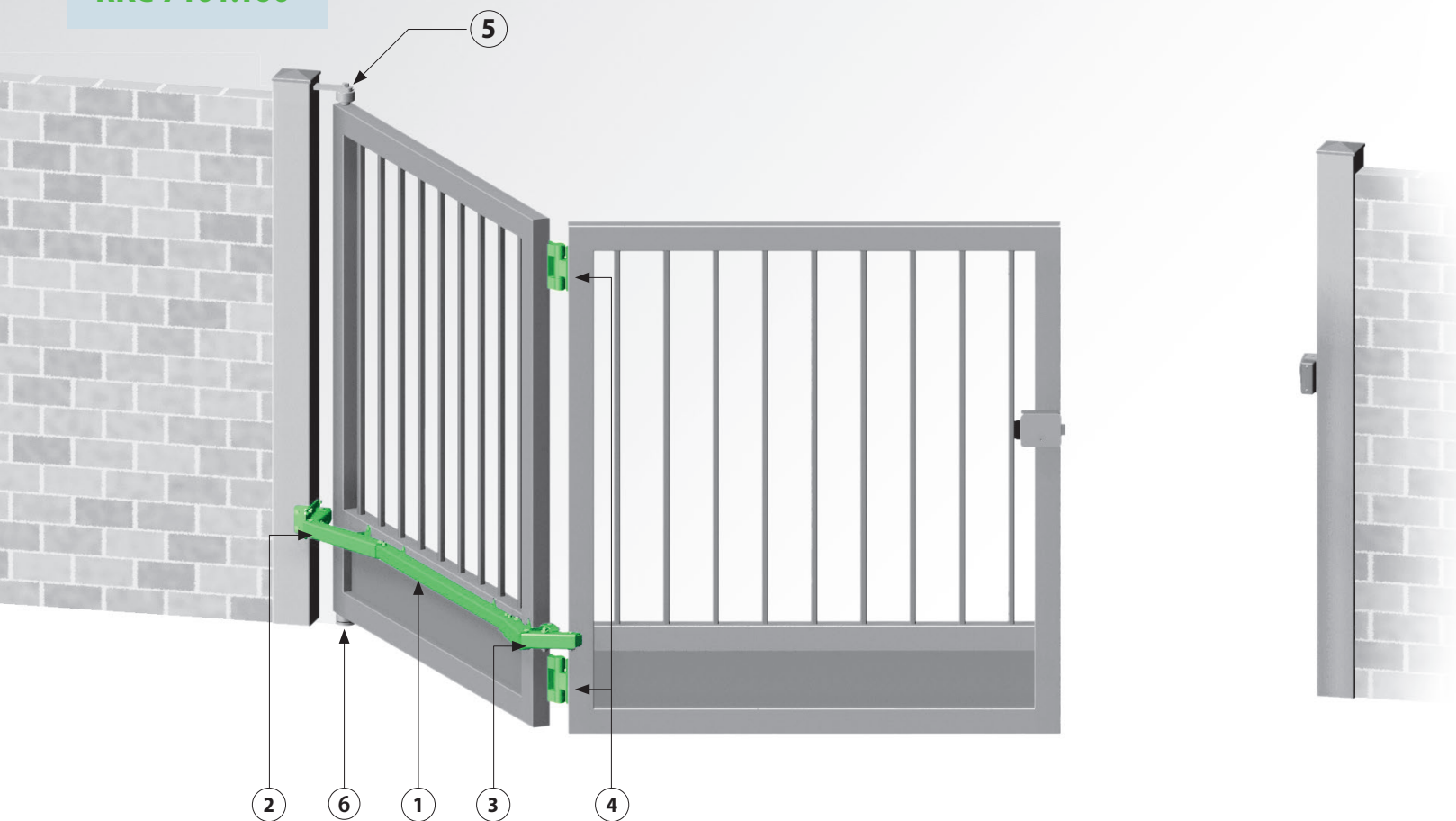

Tartozék lista

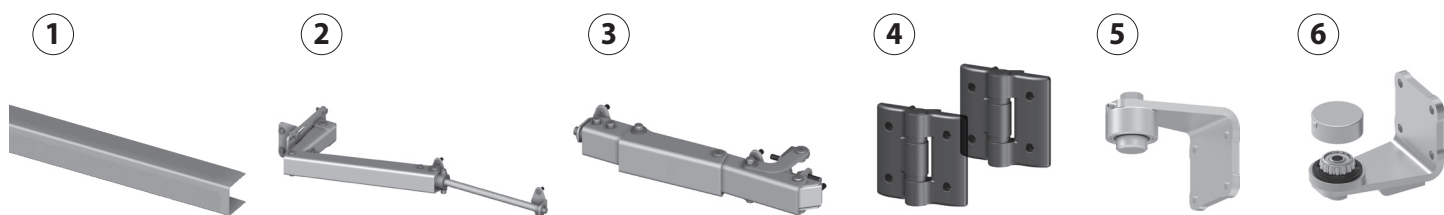

Takaró profil (fekete)
L=1900 mm

Oszlop felőli zsanér

Két tag közötti zsanér

Kivető zsanér

Felső zsanér csapágyazott

Alsó zsanér csapágyazott

Egyszárnyú kapu két tagú

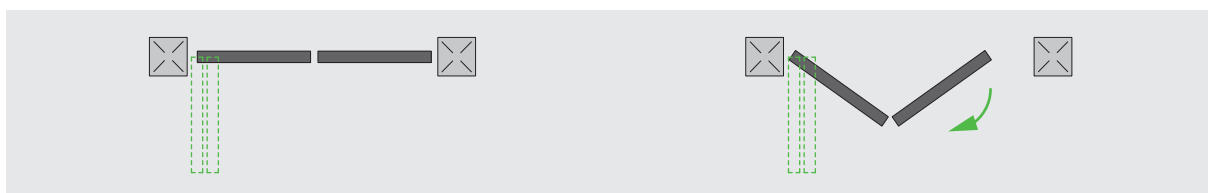

Kétszárnyú kapu négy tagú

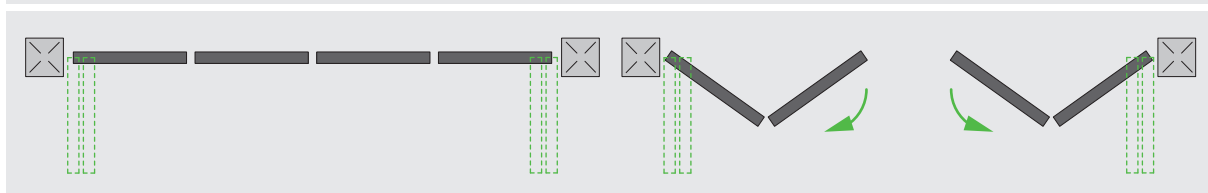



NYÍLÓKAPU EMELKEDŐ VASALAT

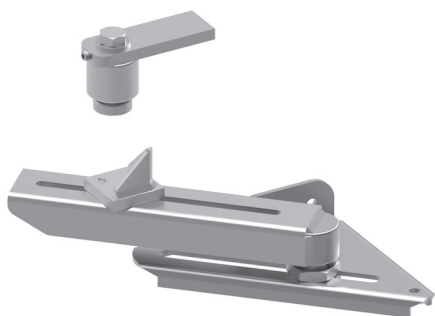

RKC 4601.L40Sx
baloldali

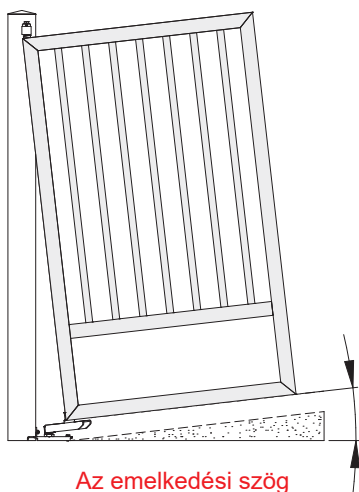

Az emelkedési szög meghatározásához kérje tervezési segédletünket!

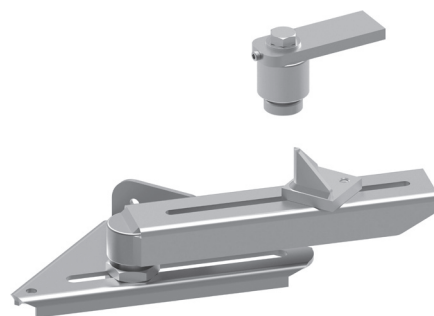

RKC 4601.L40Dx
jobboldali

TOLÓAJTÓ FELSŐ SÍNPÁLYÁK

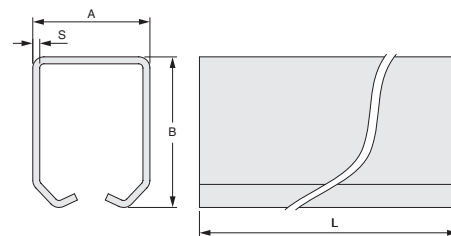
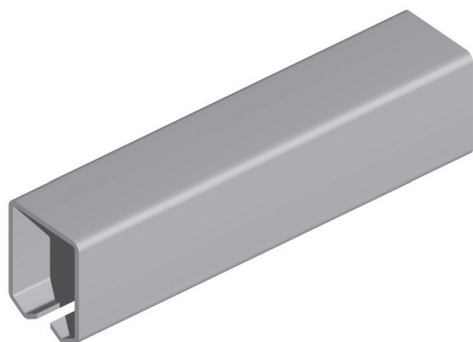

Rendelési szám	A	B	S	L (m)
RP.RF/24	33	31	2	6
RP.RF/24.3	33	31	2	3
RP.RF/45	42	54	2,5	6
RP.RF/45.3	42	54	2,5	3

RÖGZÍTŐELEM OLDALFALRA ÉS MENNYEZETRE

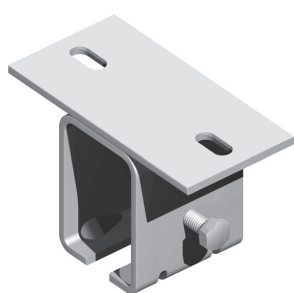

Rendelési szám
RSS 24
RSS 45

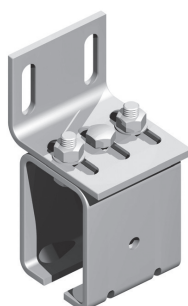

Rendelési szám
RSP 24
RSP 45

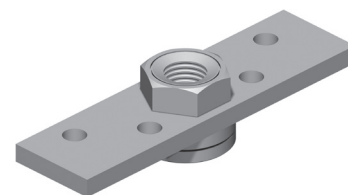

Rendelési szám	M12
VB3902.012	

4 GÖRGŐS FELSOR GÖRGŐK

Intenzív használatra is!

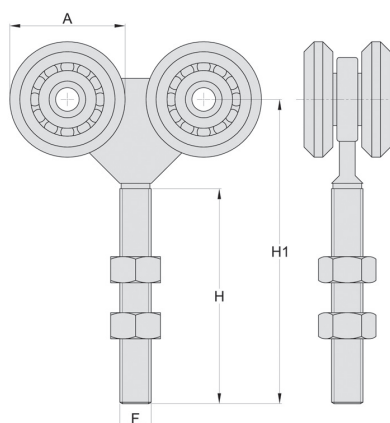

Intenzív használatra NEM ALKALMAS!



Rendelési szám	A	F	Kg	
R 4RC/45	45	M12	300	2

Rendelési szám	A	F	Kg
R 4RF/24	24	M8	75

GALVANIZÁLT SÍNPÁLYÁK, BETONOZHATÓ, CSAVAROZHATÓ



R 723.75

Ø 75 mm, Ø 16 mm csőre
terhelés: 200 kg

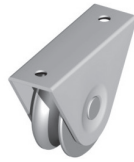

R 101/16

Ø 75 mm, Ø 16 mm csőre
terhelés: 200 kg

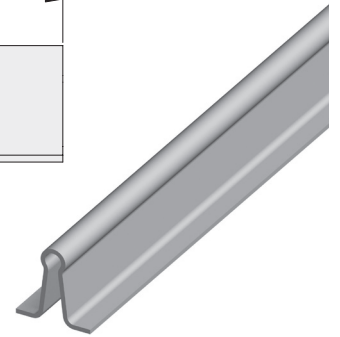
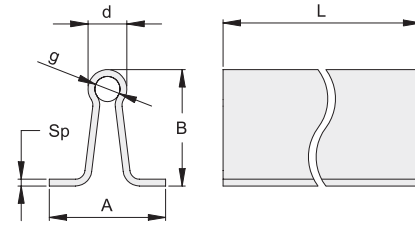

Rendelési szám	A	B	d	g	Sp.	L (m)
R816/Z	50	50	16	11	2,5	6
R816/Z3	50	50	16	11	2,5	3



R 723.75

Ø 75 mm, Ø 16 mm csőre
terhelés: 200 kg

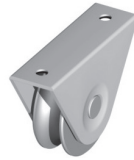

R 101/20

Ø 75 mm, Ø 20 mm csőre
terhelés: 200 kg

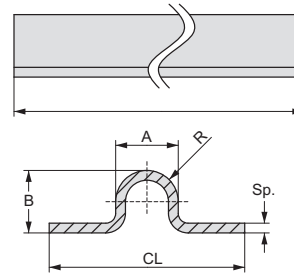

Rendelési szám	A	B	CL	R	Sp.	L (m)
R716/ZF	16	16	50	8	3	6
R716/Z3F	16	16	50	8	3	3
R720/ZF	20	16	55	10	3,5	6
R720/Z3F	20	16	55	10	3,5	3



R 721.75

Ø 75 mm,
szögvasra
terhelés: 180 kg



R 101

Ø 75 mm,
szögvasra
terhelés: 200 kg



R 101.60

Ø 60 mm,
szögvasra
terhelés: 100 kg

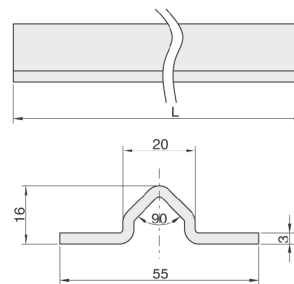

Rendelési szám	L (m)
R701/ZF	6
R701/Z3F	3



R 412

Ø 34 mm,
műanyag

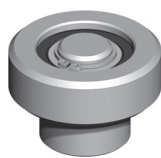

R 159C

Ø 35 mm,
csapágyazott acél

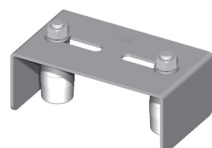

R 220

befogás: 36-60 mm

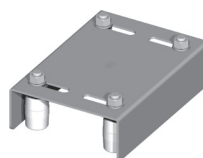

R 221

befogás: 36-60 mm

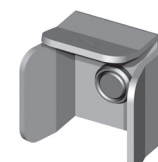

R 357.40

befogás: 44 mm

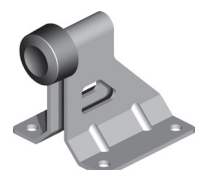

RVA 4112.125

Méretezési segédlet

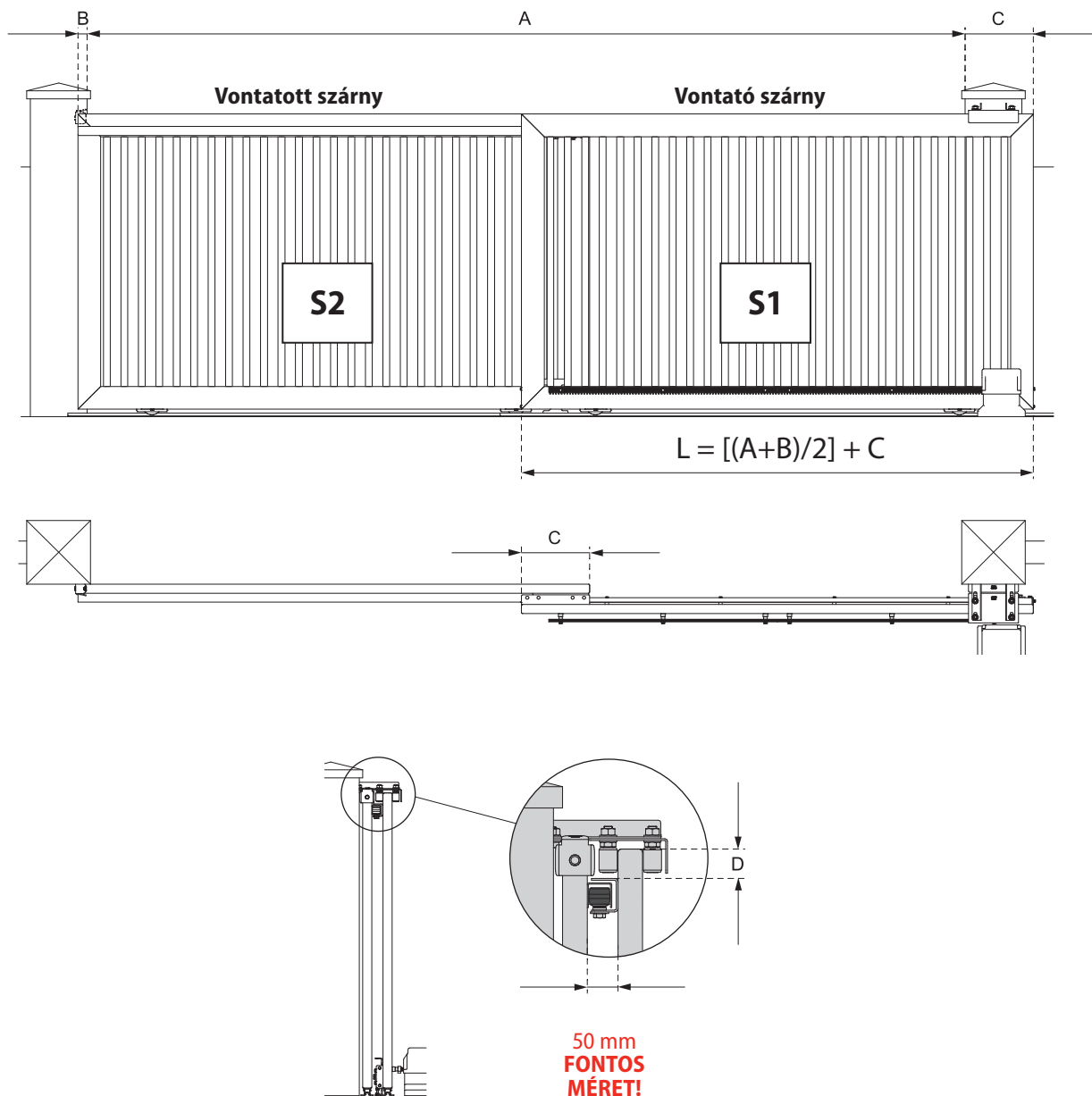

Méretezési táblázat

ÚJ CIKKSZÁM	A max (m)	C (m)	D min (mm)	S2 max (kg)
RKA5100.004	4	0,3	50	300
RKA5100.008	8	0,3	50	300

Vontató szárny méretezése a szabadnyílás függvényében

ÚJ CIKKSZÁM	SZABADNYÍLÁS (A)	L (m), ha B=0,08
RKA5100.004	3	1,84
RKA5100.004	4	2,34
RKA5100.008	5	2,84
RKA5100.008	6	3,34
RKA5100.008	7	3,84
RKA5100.008	8	4,34

Méretezési példa

A = 3,5 m
B = 0,06 m
C = 0,3 m
L = [(A+B)/2] + C
 $L = [(3,5+0,06)/2] + 0,3$
 $L = [(3,56)/2] + 0,3$
 $L = 1,78 + 0,3$
 $L = 2,08$

FIGYELEM!
A vontatott szárny sebessége duplája a vontató szárny sebességének!

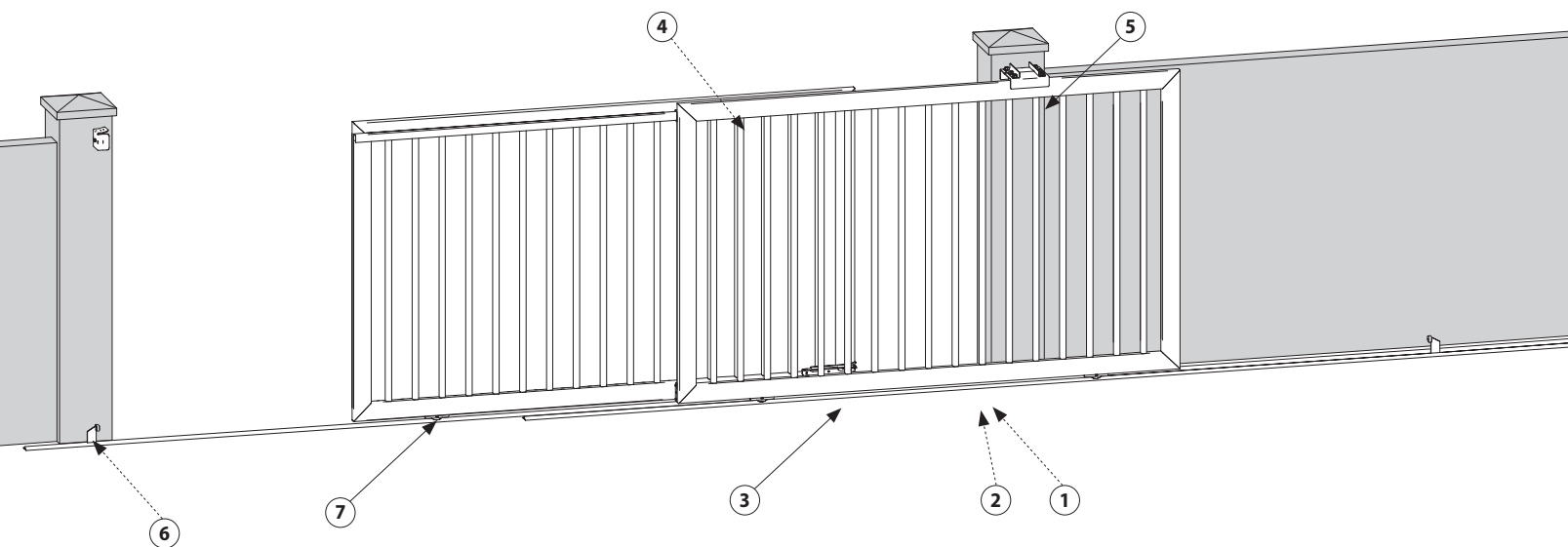

Tartozék lista



RKA5100.104

Kétszárnyú teleszkópos tolókapu rendszer 4 m szabadnyílásig

ÚJ CIKKSZÁM	MEGNEVEZÉS	
VA3501.A30	Eldőlés elleni konzol görgőkkel	1
VA3502.N34	Görgősor	1
VA5101.004	Sodrony és tartozékai 4 m szabadnyílásig	1
VA5201.004	Gyorskuplung	1
VA5301.001	Sodrony takarás	2
VA4101.092	Hegeszthető véghelyzet ütköző	3
VA1104.090	Hegeszthető, vagy csavarozható kapugörgő V-profillal	4

RKA5100.108

Kétszárnyú teleszkópos tolókapu rendszer 8 m szabadnyílásig

ÚJ CIKKSZÁM	MEGNEVEZÉS	
VA3501.A30	Eldőlés elleni konzol görgőkkel	1
VA3502.N34	Görgősor	1
VA5101.008	Sodrony és tartozékai 8 m szabadnyílásig	1
VA5201.004	Gyorskuplung	1
VA5301.001	Sodrony takarás	4
VA4101.092	Hegeszthető véghelyzet ütköző	3
VA1104.090	Hegeszthető, vagy csavarozható kapugörgő V-profillal	4

Felépítmény a kapu teljes hosszában

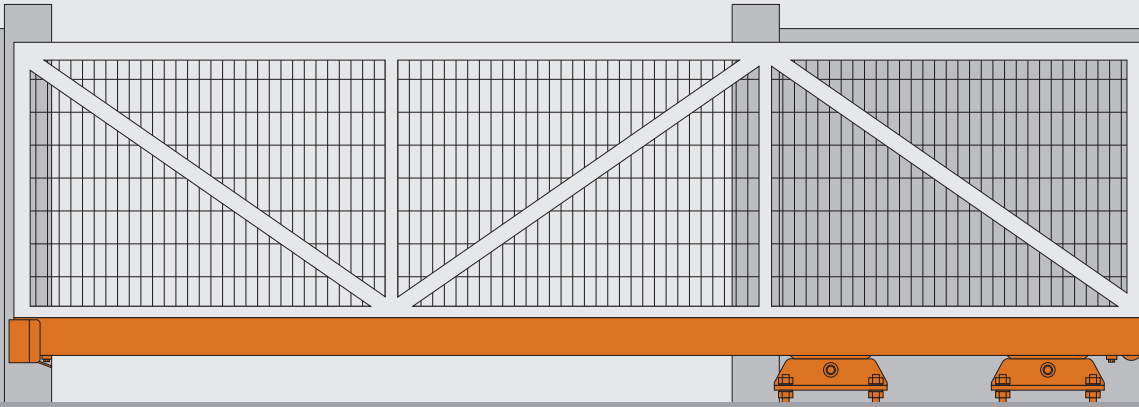

Felépítmény csak a szabadnyílásban

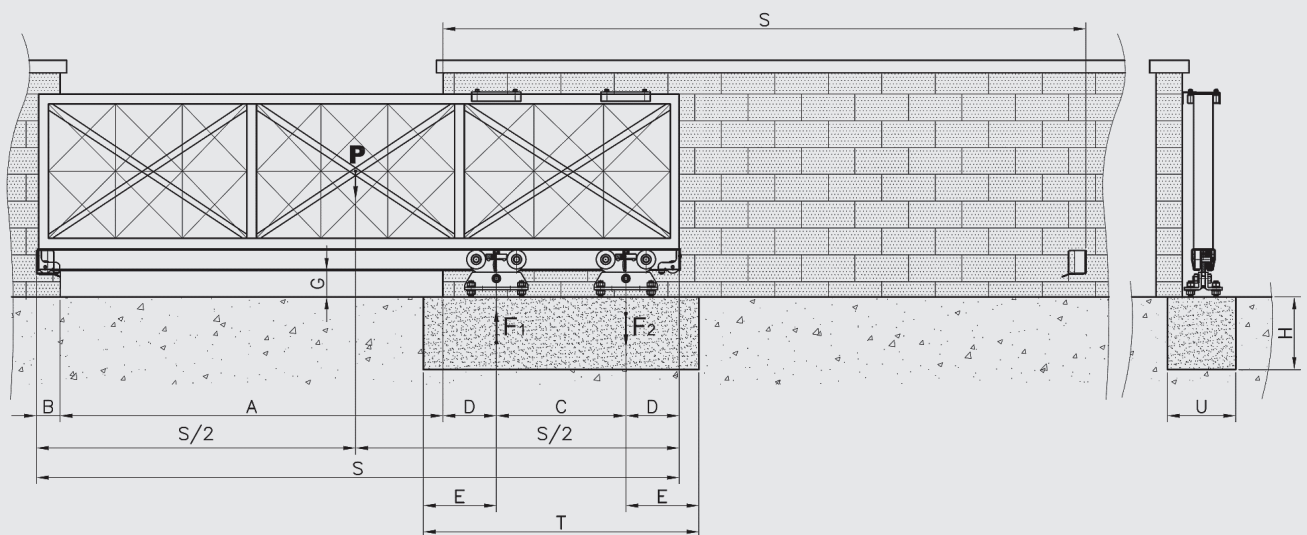
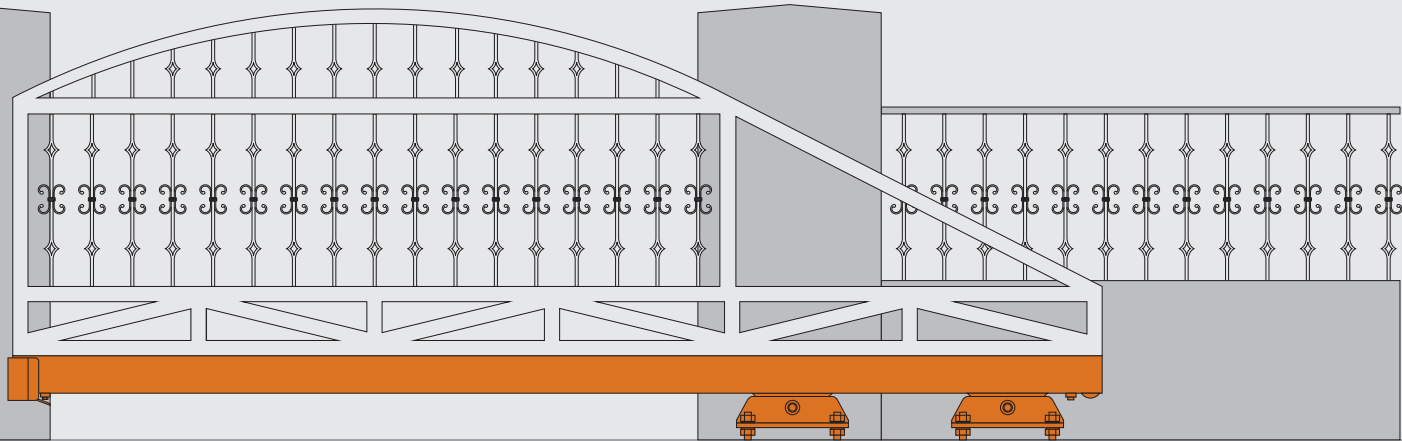

Méretek			T×U×H _{min} (m)	Felépítmény a kapu teljes hosszában			Felépítmény csak a nyílásban		
A (m)	C (m)	S (m)		Kapu teljes súlya (max) 280 kg	Betontöke súlya (min) 560 kg	Felépítmény súlya [kg]	Kapu teljes súlya (max) 210 kg	Betontöke súlya (min) 730 kg	Felépítmény súlya [kg]
2	0,8	3,1	1,3×0,4×0,9			250			180
2,3	0,9	3,5	1,4×0,4×0,9			250			180
2,6	1,1	4,0	1,5×0,4×0,9			250			180
3	1,2	4,5	1,7×0,4×0,9			250			180
3,3	1,3	4,9	1,8×0,4×0,9			240			180
3,6	1,5	5,4	1,9×0,4×0,9			240			180
4	1,6	5,9	2,1×0,4×0,9			240			170
Fix adatok: F_{1max} (kg): 500 D (m): 0,115 B (m): 0,070 G_{min} (m): 0,05 E_{min} (m): 0,25									

800-as család

Méretek			T×U×H _{min} (m)	Felépítmény a kapu teljes hosszában			Felépítmény csak a nyílásban		
A (m)	C (m)	S (m)		Kapu teljes súlya (max) 450 kg	Betontöke súlya (min) 900 kg	Felépítmény súlya [kg]	Kapu teljes súlya (max) 340 kg	Betontöke súlya (min) 1210 kg	Felépítmény súlya [kg]
3	1,2	4,7	1,8×0,5×0,9			400			290
3,5	1,4	5,4	2,0×0,5×0,9			400			290
4	1,6	6,1	2,2×0,5×0,9			390			280
4,5	1,8	6,8	2,4×0,5×0,9			390			280
5	2,0	7,5	2,6×0,5×0,9			380			270
5,5	2,2	8,2	2,8×0,5×0,9			380			270
6	2,4	8,9	3,0×0,5×0,9			370			270
Fix adatok: F_{1max} (kg): 800 D (m): 0,195 B (m): 0,110 G_{min} (m): 0,06 E_{min} (m): 0,30									

900-as család

Méretek			T×U×H _{min} (m)	Felépítmény a kapu teljes hosszában			Felépítmény csak a nyílásban		
A (m)	C (m)	S (m)		Kapu teljes súlya (max) 565 kg	Betontöke súlya (min) 1110 kg	Felépítmény súlya [kg]	Kapu teljes súlya (max) 425 kg	Betontöke súlya (min) 1490 kg	Felépítmény súlya [kg]
3	1,2	4,8	1,9×0,6×0,9			600			450
3,5	1,4	5,5	2,1×0,6×0,9			600			450
4	1,6	6,2	2,3×0,6×0,9			600			450
4,5	1,8	6,9	2,5×0,6×0,9			600			450
5	2,0	7,6	2,7×0,6×0,9			600			450
5,5	2,2	8,3	2,9×0,6×0,9			600			450
6	2,4	9,0	3,1×0,6×0,9			600			450
7	2,8	10,4	3,5×0,6×0,9			600			450
8	3,2	11,8	3,9×0,6×0,9	600	450				
Fix adatok: F_{1max} (kg): 1000 D (m): 0,260 B (m): 0,115 G_{min} (m): 0,08 E_{min} (m): 0,35									

1000-es család

Méretek			T×U×H _{min} (m)	Felépítmény a kapu teljes hosszában			Felépítmény csak a nyílásban		
A (m)	C (m)	S (m)		Kapu teljes súlya (max) 850 kg	Betontöke súlya (min) 1655 kg	Felépítmény súlya [kg]	Kapu teljes súlya (max) 645 kg	Betontöke súlya (min) 2210 kg	Felépítmény súlya [kg]
3	1,2	4,9	2,1×0,8×0,9			1200			900
4	1,6	6,3	2,5×0,8×0,9			1200			900
5	2,0	7,7	2,9×0,8×0,9			1200			900
6	2,4	9,1	3,3×0,8×0,9			1200			900
7	2,8	10,5	3,7×0,8×0,9			1200			900
8	3,2	11,9	4,1×0,8×0,9			1200			900
9	3,6	13,3	4,5×0,8×0,9			1200			900
10	4	14,7	4,9×0,8×0,9			1200			900
12	4,8	17,5	5,7×0,8×0,9	1200	900				
Fix adatok: F_{1max} (kg): 1500 D (m): 0,290 B (m): 0,115 G_{min} (m): 0,08 E_{min} (m): 0,45									

2000-es család

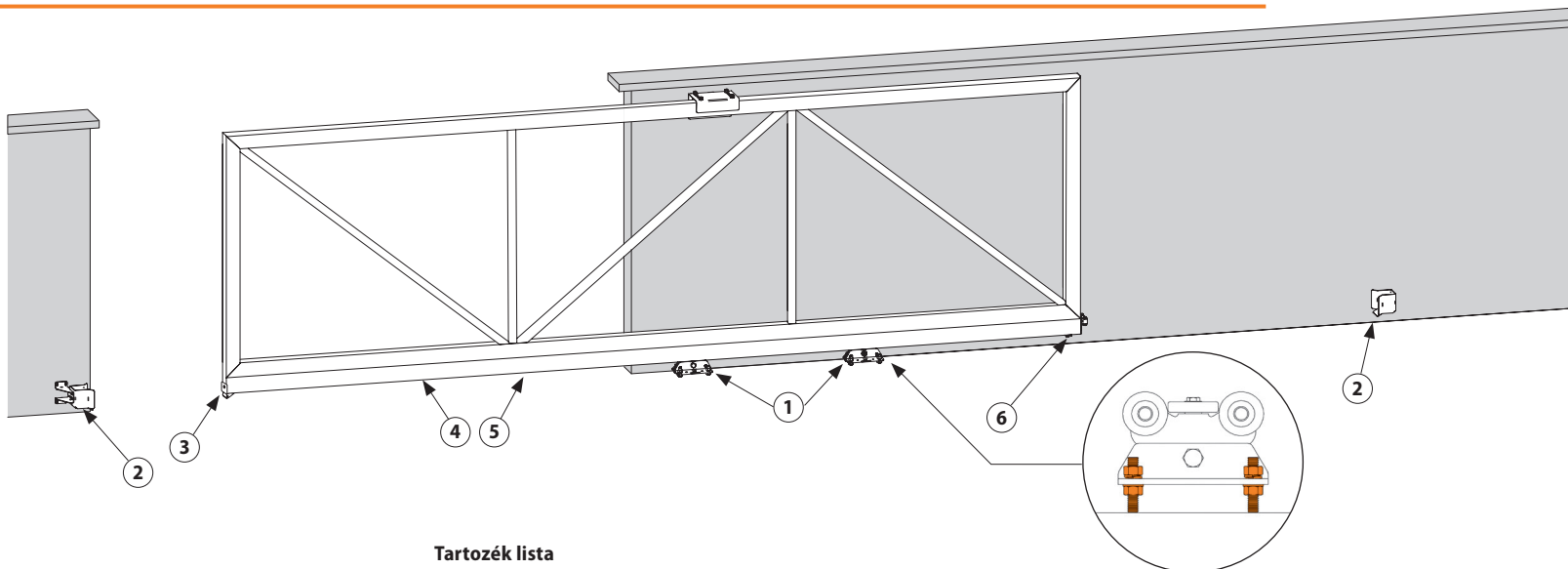

Tartozék lista

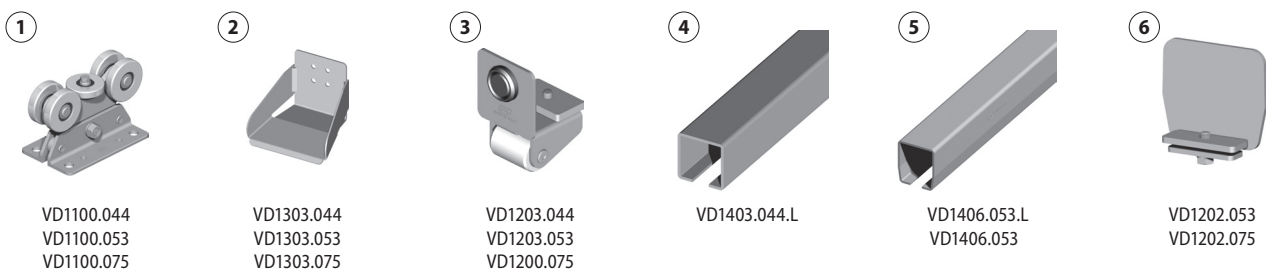

RKD1000.080

Úszó-tolókapu rendszer max. 4 m szabadnyílásig / max. 170 kg kapusúlyig

ÚJ CIKKSZÁM	RÉGI CIKKSZÁM	MEGNEVEZÉS		800-as család
VD1100.044	R810	Görgőcsoport	2	
VD1203.044	R823	Végzáró kerékkel	1	
VD1303.044	R833	Fogadó	1	
VD1406.044.L	RP.44	"C"-metszetű szelvény – fekete, metszete 50x50x3,0 mm	1	

RKD1000.090

Úszó-tolókapu rendszer max. 6 m szabadnyílásig / max. 270 kg kapusúlyig

ÚJ CIKKSZÁM	RÉGI CIKKSZÁM	MEGNEVEZÉS		900-as család
VD1100.053	R910S	Görgőcsoport	2	
VD1203.053	R923	Végzáró kerékkel	1	
VD1303.053	-	Fogadó	1	
VD1406.053.L	RP.53M	"C"-metszetű szelvény – fekete, metszete 60x70x3,5 mm	1	
VD1202.053	R925	Végzáró lemez	1	

RKD1000.090/Z

Úszó-tolókapu rendszer max. 6 m szabadnyílásig / max. 270 kg kapusúlyig

ÚJ CIKKSZÁM	RÉGI CIKKSZÁM	MEGNEVEZÉS		900-as család
VD1100.053	R910S	Görgőcsoport	2	
VD1203.053	R923	Végzáró kerékkel	1	
VD1303.053	-	Fogadó	1	
VD1406.053	RP.53MZ	"C"-metszetű szelvény – horganyzott, metszete 60x70x3,5 mm	1	
VD1202.053	R925	Végzáró lemez	1	

RKD1000.100

Úszó-tolókapu rendszer max. 8 m szabadnyílásig / max. 450 kg kapusúlyig

ÚJ CIKKSZÁM	RÉGI CIKKSZÁM	MEGNEVEZÉS		1000-es család
VD1100.075	R1010	Görgőcsoport	2	
VD1200.075	R1020	Végzáró kerékkel	1	
VD1303.075	-	Fogadó	1	
VD1202.075	R1025	Végzáró lemez	1	

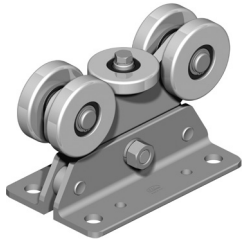

CIKKSZÁM	FELÜLET
R910S	cink/galv.
R1010	cink/galv.
R2010S	cink/galv.

CIKKSZÁM	GÖRGŐ CSOPORT	HOSSZ (m)	FELÜLET
RP.53/3	R910S	3	fekete
RP.53	R910S	6	fekete
RP.75/3	R1010	3	fekete
RP.75/4	R1010	4	fekete
RP.75	R1010	6	fekete
RP.100/3	R2010S	3	fekete
RP.100	R2010S	6	fekete
RP.53/Z/3	R910S	3	cink/galv.
RP.53/Z	R910S	6	cink/galv.
RP.75/Z/3	R1010	3	cink/galv.
RP.75/Z	R1010	6	cink/galv.
RP.100/Z/3	R2010S	3	cink/galv.
RP.100/Z	R2010S	6	cink/galv.

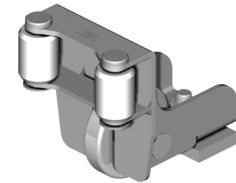
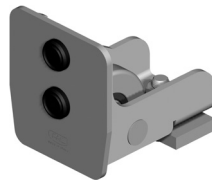

CIKKSZÁM	GÖRGŐCSOPORT	FELÜLET
R923	R910S	cink/galv.

RÉGI CIKKSZÁM	GÖRGŐCSOPORT	FELÜLET
R920	R910S	cink/galv.
R1020	R1010	cink/galv.
R2020	R2010S	cink/galv.

CIKKSZÁM	GÖRGŐCSOPORT	FELÜLET
R1021	R1010	cink/galv.
R2021	R2010S	cink/galv.

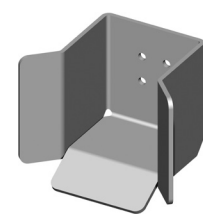
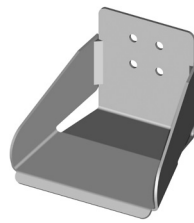
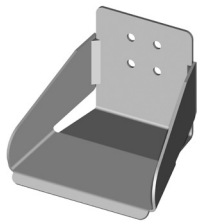

CIKKSZÁM	VÉGZÁRÓ	FELÜLET
R930	R920, R923	cink/galv.

CIKKSZÁM	VÉGZÁRÓ	FELÜLET
R1030	R1020	cink/galv.
R2030.1	R2020	cink/galv.

CIKKSZÁM	VÉGZÁRÓ	FELÜLET
R2031	R1021, R2021	cink/galv.

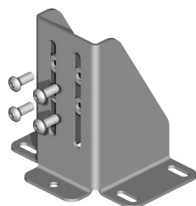

CIKKSZÁM	FOGADÓK	FELÜLET
R935	R930	cink/galv.
R1035	R1030, R2030	cink/galv.

CIKKSZÁM	"C"-METSZETŰ SZELVÉNY	FELÜLET
R925	RP.53	cink/galv.
R1025	RP.75	cink/galv.
R2025	RP.100	cink/galv.

