

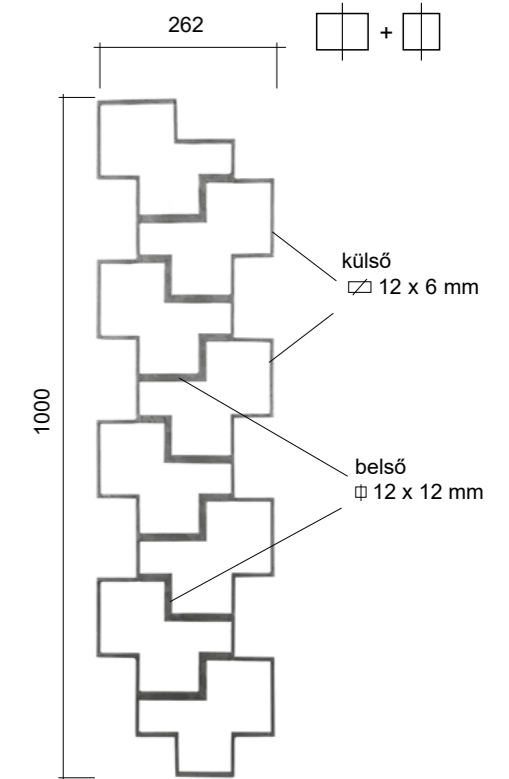

## Tartalomjegyzék

Korlátpálcák, korlátpanelek .....	1
Korlátindító oszlopok .....	28
Talplemezek .....	29
Fűzhető közbenső díszek .....	30
Rozetták .....	32
C- és S-minták .....	38
Golyók, karikák .....	41
Korlátgömbök .....	42
Levelek, virágminták .....	43
Csúcsdíszek .....	46
Kerítéspálcák .....	49
Festékek, szegecsek .....	50
Kilincsek .....	51
Kapupántok/Házzszámok .....	52
Bilincanyagok .....	53
Szálanyagok .....	54
Korláttetők .....	58
Végzárók .....	59
Rozsdamentes elemek .....	60
Kapuvasalatok .....	71



**RGD 293/1**  
 □ 12x6 mm + □ 12 mm  
 1000x262 mm

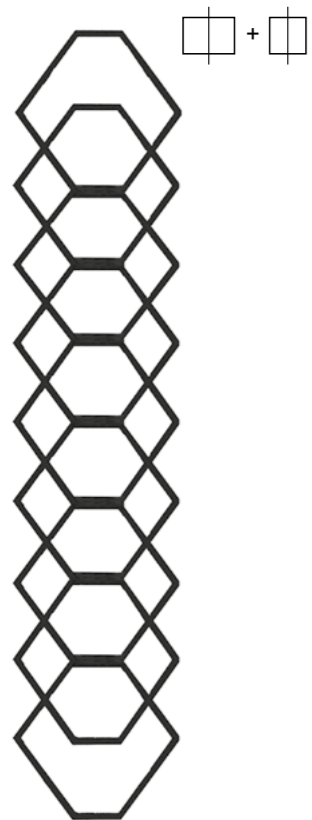

**RGD 299/3**  
 □ 16×8 mm + □ 8 mm  
 1000×200 mm



**RGD 299/4**  
 □ 16×8 mm + □ 8 mm  
 458×600 mm

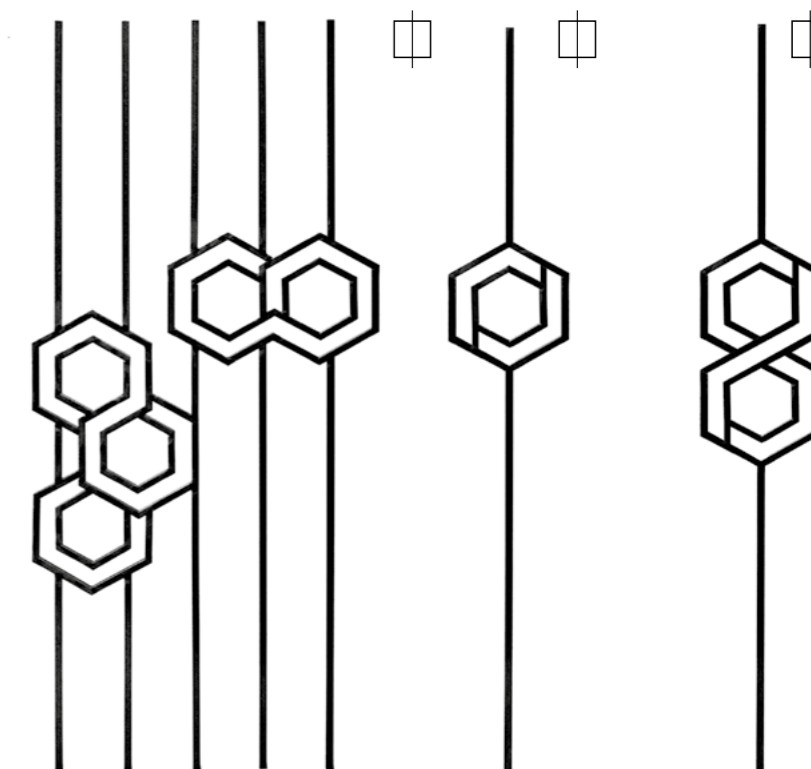

**RGD 301/3**  
 □ 12 mm  
 1000×568 mm

**RGD 301/4**  
 □ 12 mm  
 1000×197 mm

**RGD 301/5**  
 □ 12 mm  
 1000×197 mm

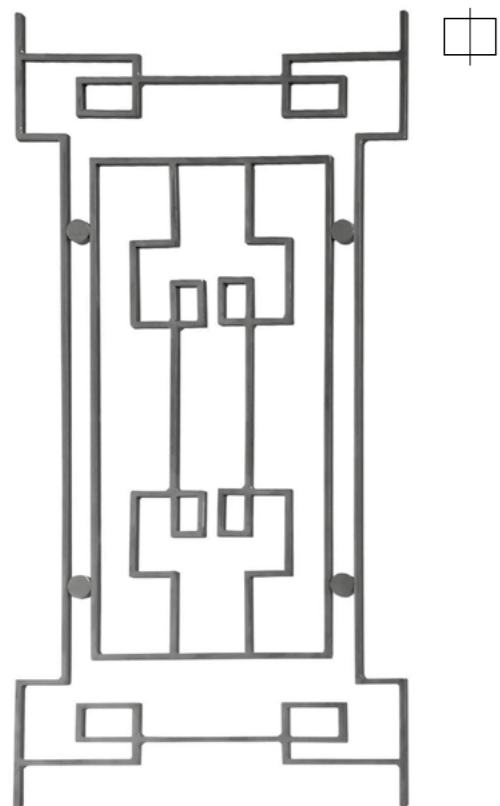

**RGD 202/1**  
 ▧ 14×8 mm  
 1000×500 mm

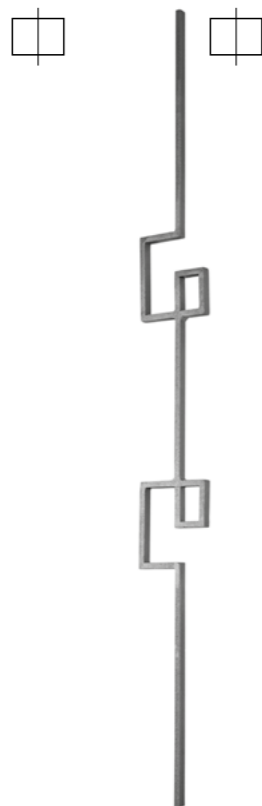

**RGD 202/2**  
 ▧ 14×8 mm  
 1000×95 mm



**RGD 202/6**  
 ▧ 14×8 mm  
 1000×80 mm

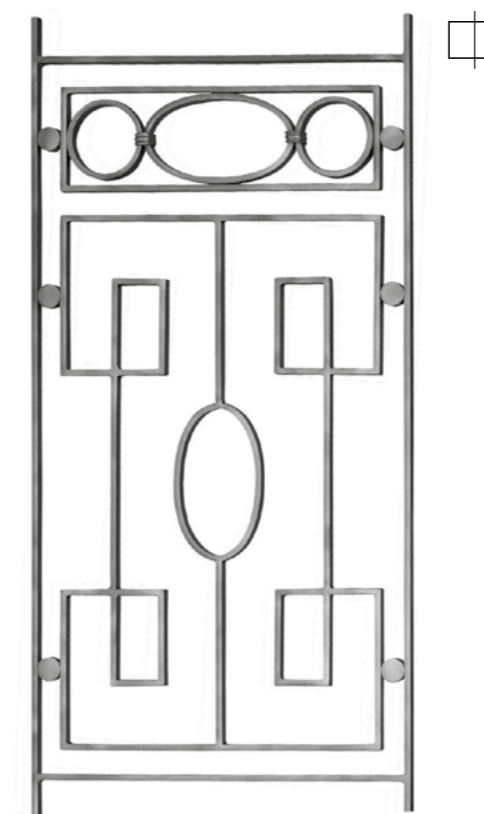

**RGD 205/1**  
 ▧ 14×8 mm  
 495×1000 mm

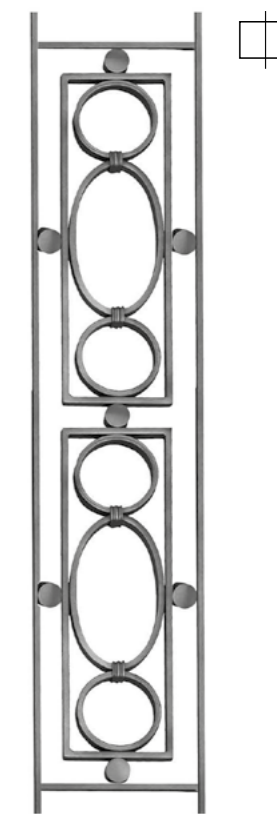

**RGD 205/2**  
 ▧ 14×8 mm  
 210×1000 mm



**RGD 28/1**  
 □ 14×14 mm  
 215×1000 mm

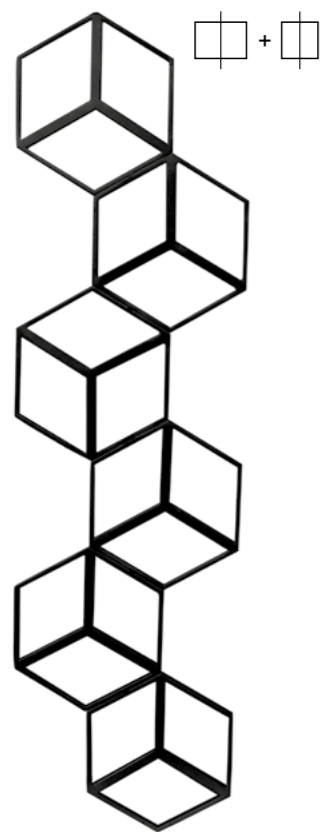

**RGD 287/2**  
 □ 12×6 mm + □ 12 mm  
 1000×274 mm



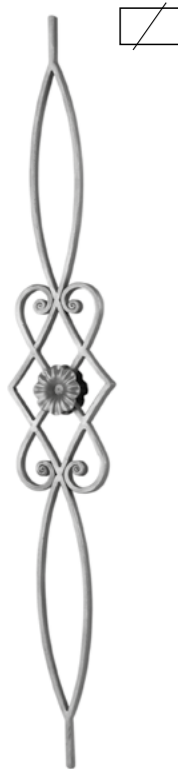

**RGD 16/1**  
 14×8 mm  
 160×1000 mm



**RGD 176/3**  
 14×14 mm  
 200×1000 mm



**RGD 20/1**  
 12×12 mm  
 110×1000 mm



**RGD 158/1**  
 14×8 mm  
 160×1000 mm



**RGD 202/3**  
 14×8 mm  
 500×1000 mm

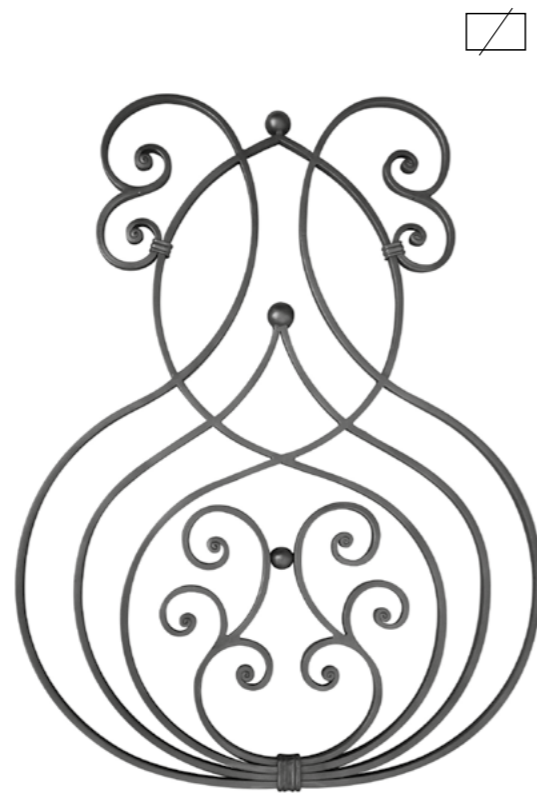

**RGD 231/2**  
 14×8 mm  
 600 x 800 mm



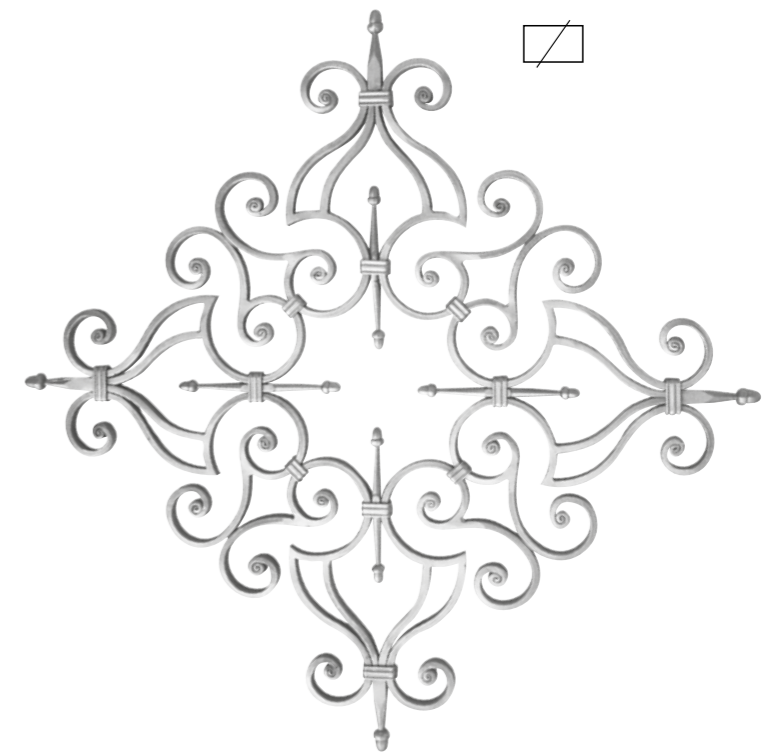

**RGD 151/2**  
 □ 14×8 mm  
 770×500 mm



**RGD 223/1**  
 □ 14×8 mm  
 275×1000 mm



**RF 9075/2**  
 □ 14×8 mm  
 H 1000 mm



**RGD 222/1**  
 □ 14×8 mm  
 500×1000 mm





**RGD 20/5**  
□ 12×12 mm  
180×1000 mm



**RGD 20/8**  
□ 12×12 mm  
200×1000 mm



**RGD 21/3**  
□ 12×12 mm  
200×1000 mm

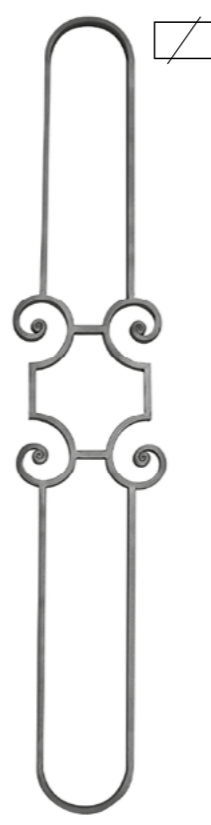

**RGD 245/3**  
▧ 14×8 mm  
180×1000 mm

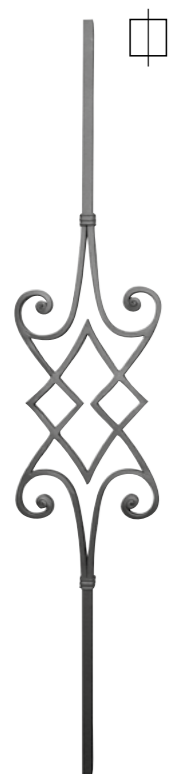

**RGD 154/3**  
□ 14×14 mm  
190×1000 mm



**RGD 16/2**  
▧ 14×8 mm  
160×1000 mm

ÚJ



**RGD 19/1**  
▧ 14×8 mm  
100×1000 mm



**RGD 151/1**  
□ 14×14 mm  
205×1000 mm



**RGD 150/1**  
▧ 14×8 mm  
100×1000 mm



**RGD 35/1**  
▧ 12×6 mm  
200×1000 mm



**RGD 61/3**  
□ 12×12 mm  
545 x 1000 mm



**RF 9075**  
□ 12×12 mm  
H 1000 mm



**RGD 58/3**  
□ 12×12 mm  
H 120×1000 mm



**RGD 59/2**  
□ 12×12 mm  
H 70×1000 mm



**RGD 61/1**  
□ 12×12 mm  
430 x 1000 mm

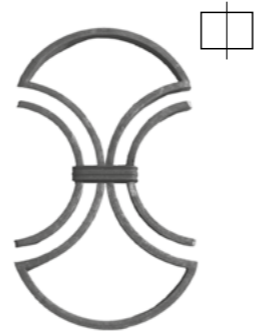

**RGD 187/2**  
 □ 14×8 mm  
 190×325 mm

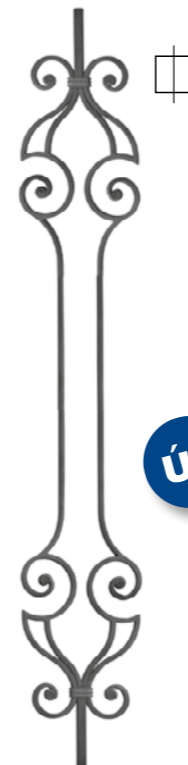

**RGD 150/2**  
 □ 14×14 mm  
 H 1000×205 mm

ÚJ



**RF 9077**  
 □ 14×8 mm  
 H 190×1000 mm

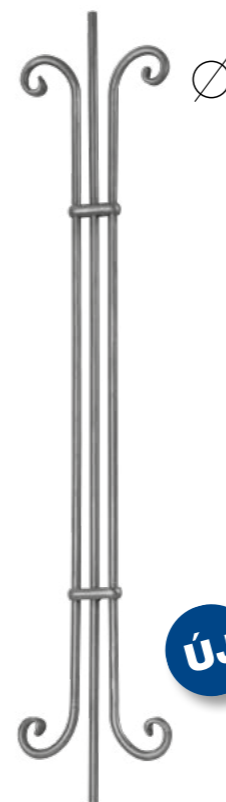

**RGD 45/2**  
 Ø 12 mm  
 H 1000×200 mm

ÚJ



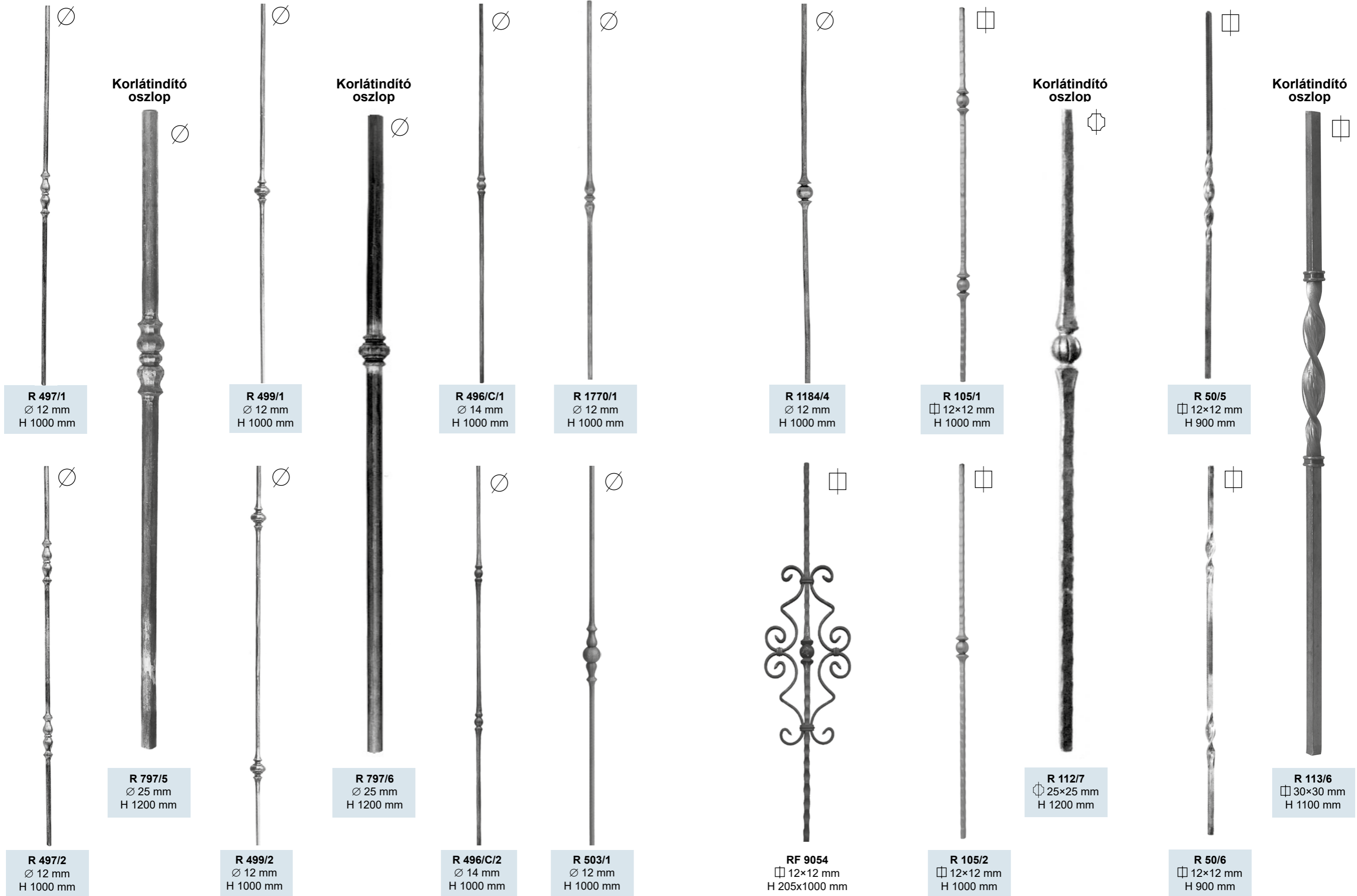

**R 497/1**  
Ø 12 mm  
H 1000 mm

**Korlátindító oszlop**

**R 499/1**  
Ø 12 mm  
H 1000 mm

**Korlátindító oszlop**

**R 496/C/1**  
Ø 14 mm  
H 1000 mm

**R 1770/1**  
Ø 12 mm  
H 1000 mm

**R 1184/4**  
Ø 12 mm  
H 1000 mm

**R 105/1**  
□ 12×12 mm  
H 1000 mm

**Korlátindító oszlop**

**R 50/5**  
□ 12×12 mm  
H 900 mm

**Korlátindító oszlop**

**R 497/2**  
Ø 12 mm  
H 1000 mm

**R 797/5**  
Ø 25 mm  
H 1200 mm

**R 499/2**  
Ø 12 mm  
H 1000 mm

**R 797/6**  
Ø 25 mm  
H 1200 mm

**R 496/C/2**  
Ø 14 mm  
H 1000 mm

**R 503/1**  
Ø 12 mm  
H 1000 mm

**RF 9054**  
□ 12×12 mm  
H 205x1000 mm

**R 105/2**  
□ 12×12 mm  
H 1000 mm

**R 112/7**  
□ 25×25 mm  
H 1200 mm

**R 50/6**  
□ 12×12 mm  
H 900 mm

**R 113/6**  
□ 30×30 mm  
H 1100 mm



**R 464/1**  
 ☒ 12×12 mm  
 H 230×900 mm

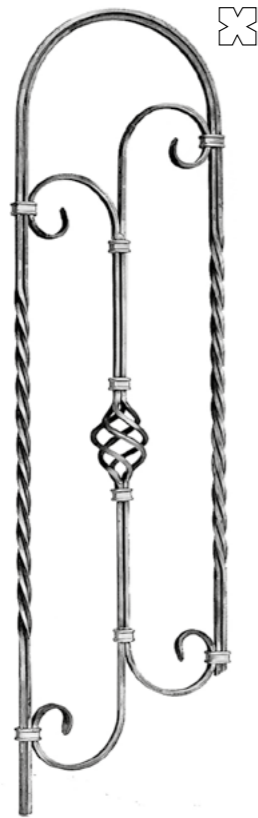

**R 464/2**  
 ☒ 12×12 mm  
 H 230×900 mm

**Korlátindító oszlop**



**R 1724/50**  
 ☒ 30×30 mm  
 H 1200 mm



**R 587/41**  
 ☒ 12×12 mm  
 H 830 mm



**R 587/45**  
 ☒ 12×12 mm  
 H 830 mm



**R 1702/2**  
 ☒ 14×14 mm  
 H 1000 mm



**R 1702/6**  
 ☒ 14×14 mm  
 H 1000 mm

**Korlátindító oszlop**



**R 1702/15**  
 ☒ 25×25 mm  
 H 1200 mm

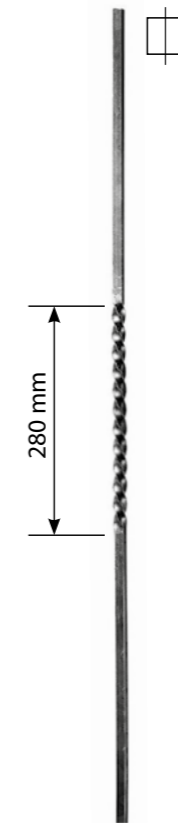

**R 1148/5**  
 ☒ 12×12 mm  
 H 1000 mm



**R 1148/8**  
 ☒ 12×12 mm  
 H 1000 mm

**Korlátindító oszlop**



**R GD 22/6**  
 ☒ 30×30 mm  
 H 1200 mm



**R 64/L/3**  
 Ø 14 mm  
 H 900 mm



**R 64/L/4**  
 Ø 14 mm  
 H 900 mm

**Korlátindító oszlop**



**R 1775/1**  
 Ø 25 mm  
 H 1200 mm



**R 118/H/1**  
 ☒ 12×12 mm  
 H 900 mm



**R 118/H/2**  
 ☒ 12×12 mm  
 H 900 mm



**RF 9031**  
 ☒ 12×12 mm  
 H 900 mm

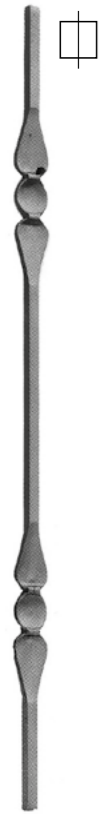

**R 134/10**  
□ 12×12 mm  
H 1000 mm



**R 134/2**  
□ 12×12 mm  
H 1000 mm



**RF 9036**  
□ 12×12 mm  
H 1000 mm

Korlátindító oszlop



**R 1775/4**  
□ 25×25 mm  
H 1200 mm



**R 1701/1**  
□ 12×12 mm  
H 1000 mm



**R 1701/5**  
□ 12×12 mm  
H 1000 mm



**R 1701/3**  
□ 12×12 mm  
H 1000 mm

Korlátindító oszlop



**R 1701/15**  
□ 25×25 mm  
H 1200 mm



**RF 9034**  
□ 12×12 mm  
170×1000 mm



**RF 9056**  
□ 12×12 mm  
H 205×1000 mm



**RF 9038**  
□ 12×12 mm  
170×1000 mm



**RF 9039**  
□ 12×12 mm  
170×1000 mm



**RF 9040**  
□ 12×12 mm  
H 1000 mm



**RF 9042**  
□ 12×12 mm  
170×1000 mm

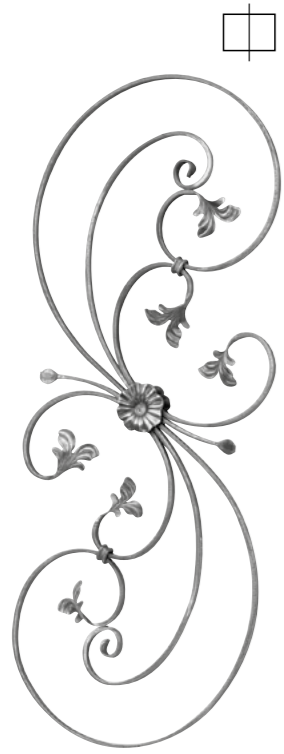

**R 1670/2**  
 □ 12×6 mm  
 350×870 mm

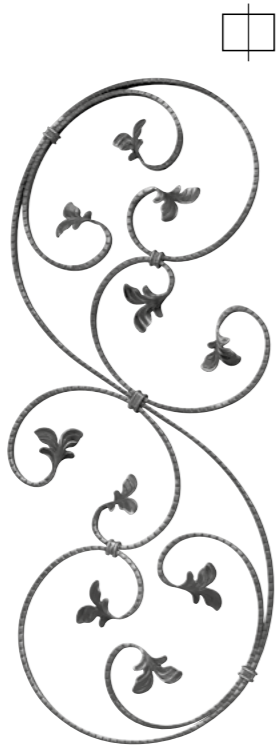

**R 1671/3**  
 □ 12×6 mm  
 350×870 mm



**R 52/1**  
 □ 12×6 mm  
 350×870 mm



**R 1670/1**  
 □ 12×6 mm  
 360×1000 mm



**R 463/1**  
 □ 12×6 mm  
 210×790 mm

**Korlátindító oszlop**



**R 113/2**  
 □ 30×30 mm  
 H 1100 mm



**R 1171/2**  
 Ø 12 mm  
 60×1000 mm



**R 1681/1**  
 □ 14×8 mm  
 190×1000 mm



**R 1680/2**  
 □ 14×8 mm  
 190×1000 mm



**RF 9055**  
 □ 12×6 mm  
 190×900 mm



**R 471/1**  
 □ 14×8 mm  
 250×900 mm



**R 463/2**  
 □ 12×6 mm  
 210×660 mm



**RF 90100**  
 Ø 12 mm  
 60×1000 mm



**R 1171/1**  
 Ø 12 mm  
 120×1000 mm



**R 1730/1**  
 □ 12×12 mm  
 H 1000 mm



**R 1730/3**  
 □ 12×12 mm  
 H 1000 mm



**R 1730/5**  
 □ 12×12 mm  
 H 1000 mm



**R 1730/7**  
 □ 12×12 mm  
 H 1000 mm



**R 1720/11**  
 □ 12×12 mm  
 H 1000 mm



**R 578/1**  
 □ 12×12 mm  
 H 900 mm

**R 578/2**  
 □ 14×14 mm  
 H 900 mm



**R 578/3**  
 □ 12×12 mm  
 H 900 mm

**R 578/4**  
 □ 14×14 mm  
 H 900 mm

**RF 9026**  
 □ 12×12 mm  
 H 170×900 mm



**RF 9025**  
 □ 12×12 mm  
 H 900 mm



**Korlátindító oszlop**



**R 149/1**  
 Ø 30 mm  
 H 900 mm



**R 1718/7**  
 □ 12×12 mm  
 H 1000 mm



**RF 9015**  
 □ 12×12 mm  
 H 1000 mm



**RF 9018**  
 □ 12×12 mm  
 H 1000 mm



**RF 9050**  
 □ 12×12 mm  
 H 1000 mm



**RF 9030**  
 □ 12×12 mm  
 100×900 mm



**RF 9024**  
 □ 12×12 mm  
 200×900 mm

Virág csak az egyik oldalon

**R 578/5**  
 □ 12×12 mm  
 110×900 mm



**RF 9027**  
 □ 12×12 mm  
 150×900 mm

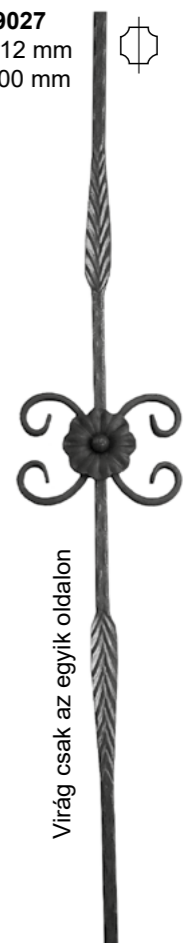

Virág csak az egyik oldalon

**R 801/2**  
 □ 25×25 mm  
 H 1200 mm

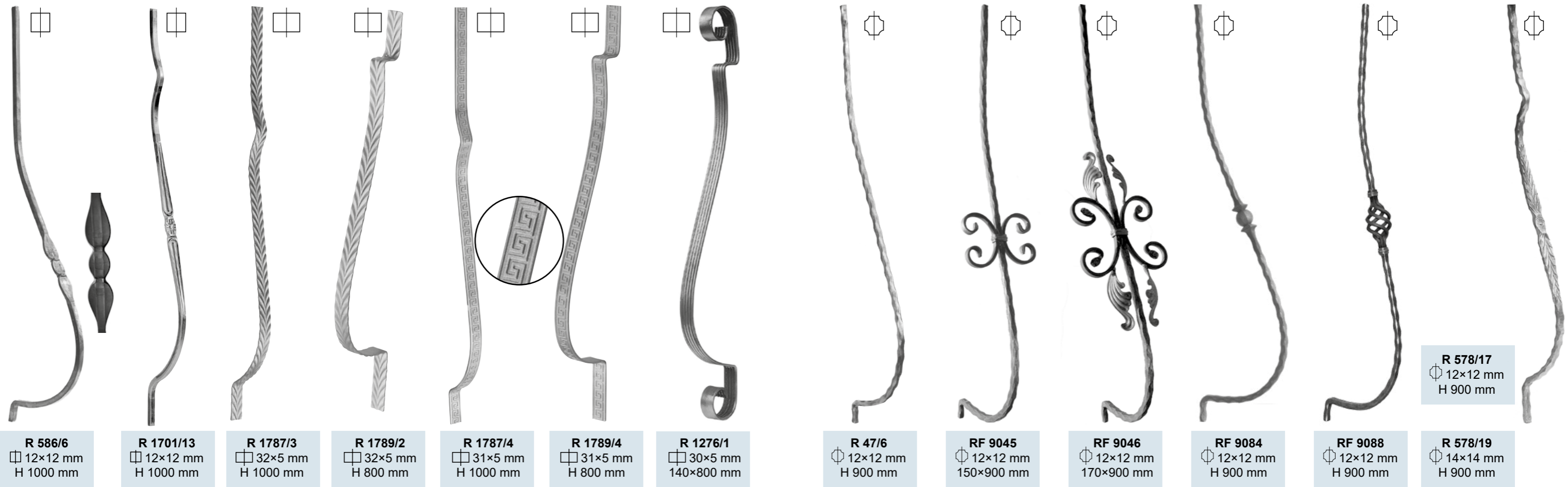
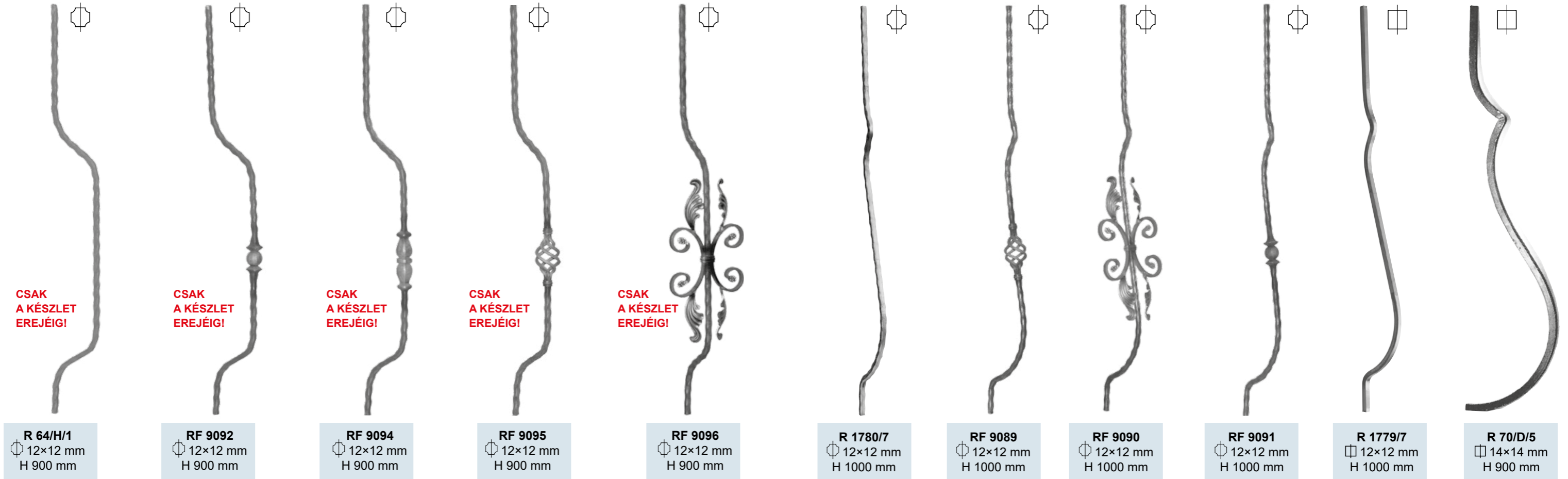



**R 112/9**  
 ∅ 30×30 mm  
 H 1200 mm



**R 112/11**  
 ∅ 30×30 mm  
 H 1200 mm



**R 1724/26**  
 ∅ 30×30 mm  
 H 1200 mm



**R 1725/12**  
 ∅ 30×30 mm  
 H 1200 mm



**RF 9103/1**  
 ∅ 25×25 mm  
 H 1200 mm

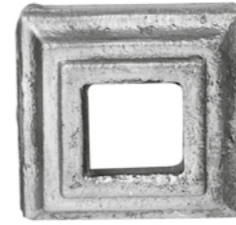

**R 819/1**  
 ∅ 60×60 mm  
 furat ∅ 30 mm

**R 819/2**  
 ∅ 60×60 mm  
 furat ∅ 25 mm

**R 819/3**  
 ∅ 50×50 mm  
 furat ∅ 20 mm

**R 819/16**  
 ∅ 80×80 mm  
 furat ∅ 40 mm



**R 1408/6**  
 ∅ 60 mm  
 furat ∅ 31 mm

**R 1408/7**  
 ∅ 60 mm  
 furat ∅ 25 mm



**R 1408/1**  
 ∅ 80×80 mm  
 furat ∅ 26 mm

**R 1408/2**  
 ∅ 55×55 mm  
 furat ∅ 15 mm



**RN 0050**  
 ∅ 6 mm  
 100×220 mm



**R 1857/13**  
 ∅ 82 mm  
 ∅ 4 mm



**R 1393/7**  
 ∅ 68×10 mm  
 furat ∅ 12,5 mm

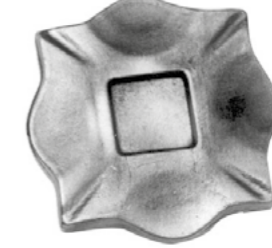

**R 116/A/6**  
 ∅ 100×100 mm  
 ∅ 10 mm

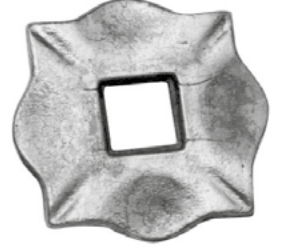

**R 116/A/7**  
 ∅ 100×100 mm  
 ∅ 10 mm  
 furat ∅ 30×30 mm



**R 146/2**  
 ∅ 40 mm  
 H 1000 mm



**RF 9115**  
 ∅ 30×30 mm  
 H 1200 mm



**RF 9114**  
 ∅ 30×30 mm  
 H 1000 mm



**R 112/10**  
 ∅ 30×30 mm  
 H 1200 mm



**RF 9112**  
 ∅ 30×30 mm  
 H 1200 mm



**R 802/4**  
 ∅ 120×120 mm  
 ∅ 10 mm

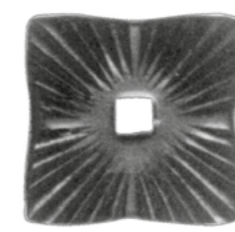

**R 116/A/2**  
 ∅ 75×75 mm  
 ∅ 5 mm

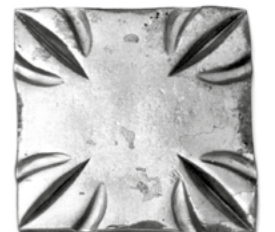

**R 94/A/3**  
 ∅ 100×100 mm  
 ∅ 8 mm

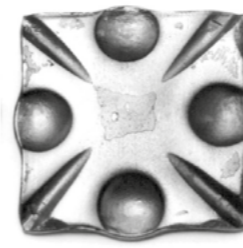

**R 94/A/6**  
 ∅ 80×80 mm  
 ∅ 8 mm

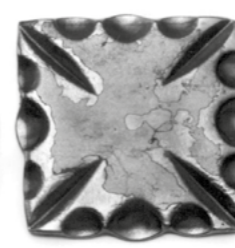

**R 94/A/4**  
 ∅ 80×80 mm  
 ∅ 8 mm

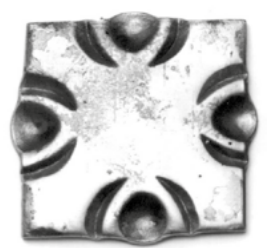

**R 94/A/5**  
 ∅ 80×80 mm  
 ∅ 8 mm



**R 158/B/1** 12×12 mm, 55×130 mm  
**R 158/B/2** 15×15 mm, 60×145 mm  
**R 158/B/3** 21×21 mm, 80×170 mm  
**R 158/B/4** 24×24 mm, 95×220 mm

**R 747/12**  
 40×65 mm  
 furat □ 12 mm



**R 747/13**  
 40×65 mm  
 furat □ 14 mm



**R 159/1** 8×8 mm, 35×90 mm  
**R 159/3** 12×12 mm, 60×125 mm  
**R 159/4** 14×14 mm, 60×125 mm  
**R 159/5** 16×16 mm, 80×165 mm  
**R 159/6** 20×20 mm, 80×165 mm  
**R 159/7** 24×24 mm, 95×180 mm  
**R 159/9** 30×30 mm, 100×220 mm  
**R 159/10** 40×40 mm, 30×280 mm



**R 158/B/7**  
 Ø 70 mm



**R 746/1**  
 40×45 mm  
 furat □ 12 mm



**R 746/5**  
 40×65 mm  
 furat □ 14 mm



**R 746/6**  
 40×38 mm  
 furat □ 14 mm

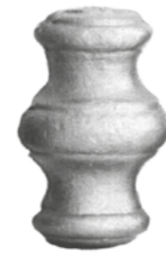

**R 128/7**  
 Ø 37×63 mm  
 furat Ø 14,5 mm



**R 741/8**  
 Ø 69×78 mm  
 furat □ 30 mm



**RF 1389/2**  
 □ 12 mm  
 35×100 mm



**R 1389/5**  
 □ 12 mm  
 30×150 mm



**R 1389/4**  
 □ 12 mm  
 30×150 mm



**R 1389/6**  
 Ø 12 mm  
 30×150 mm



**R 747/15**  
 Ø 40×39 mm  
 furat □ 12 mm



**R 747/16**  
 Ø 45×35 mm  
 furat □ 14 mm



**R 1390/5**  
 40×40×65 mm  
 furat □ 17 mm



**R 128/2**  
 Ø 40×23 mm  
 furat □ 14,5 mm



**R 128/38**  
 Ø 40×23 mm  
 furat □ 12,5 mm



**R 1244/4**  
 Ø 30×150 mm  
 furat Ø 13 mm



**R 1244/16**  
 Ø 30×155 mm  
 furat Ø 13 mm



**R 1244/17**  
 Ø 30×145 mm  
 furat Ø 13 mm



**R 154/B/3**  
 Ø 40×120 mm  
 furat Ø 14 mm



**R 1389/1**  
 □ 12 mm  
 33×200 mm



**R 154/A/1**  
 Ø 40×105 mm  
 furat Ø 14 mm



**R 1854/3**  
 Ø 35×40 mm  
 furat □ 13 mm



**R 1854/1**  
 Ø 35×40 mm  
 furat Ø 13 mm



**RGD 269/3**  
 □ 14×14 mm  
 600 x 700 mm



**RGD 234/2**  
 □ 14×8 mm  
 500 x 520 mm



**RGD 269/1**  
 ▤ 16×8 mm  
 670 x 710 mm

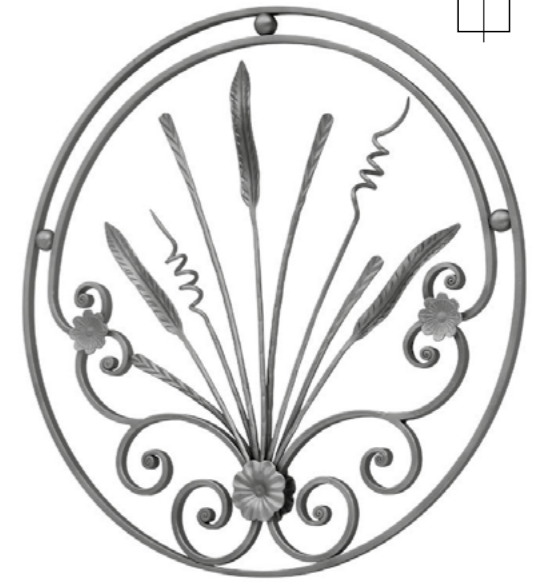

**RGD 268/2**  
 □ 14×8 mm  
 Ø 630 mm

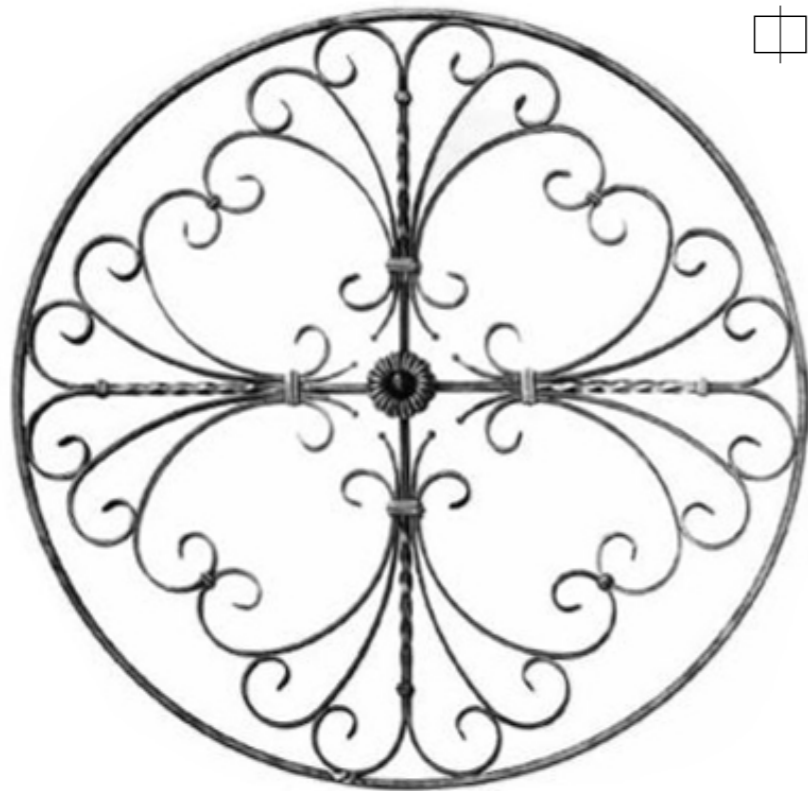

**R 457/2**  
 □ 12×6 mm  
 Ø 1045 mm



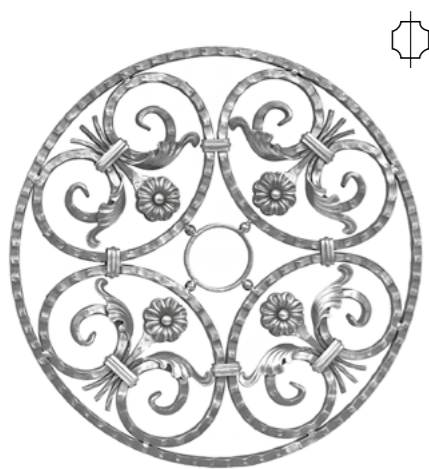

**R 459/1**  
 □ 14×14 mm  
 ∅ 610 mm

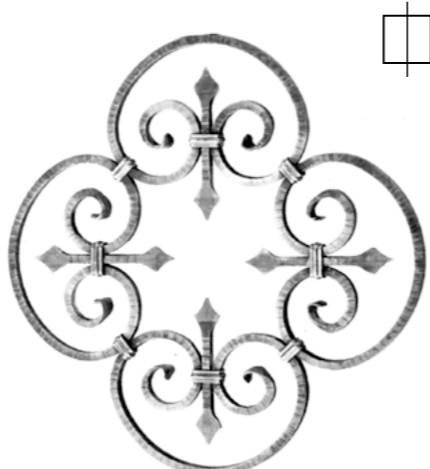

**R 24/3**  
 □ 12×12 mm  
 ∅ 600 mm

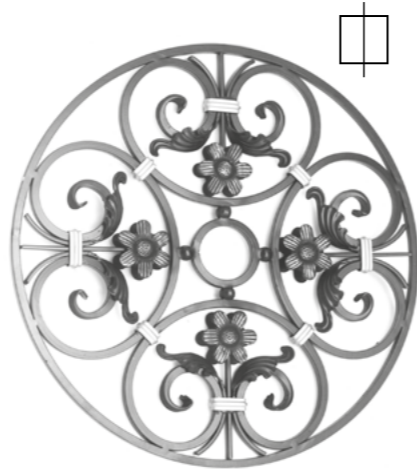

**R 24/E/1**  
 □ 12×12 mm  
 ∅ 600 mm

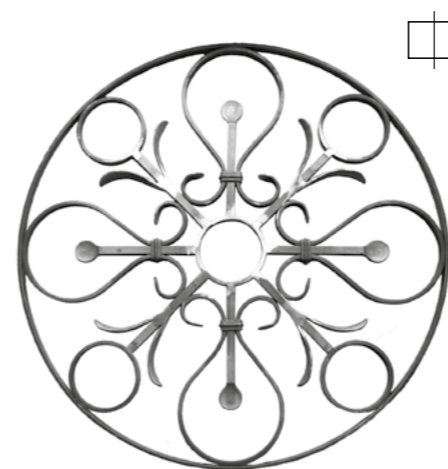

**R 1024/1**  
 □ 12×6 mm  
 ∅ 615 mm



**R 449/1**  
 □ 12×6 mm  
 ∅ 430 mm



**R 1020/1**  
 □ 12×6 mm  
 ∅ 590 mm

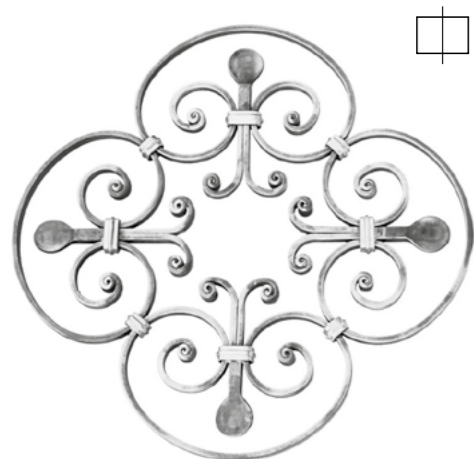

**R 1655/1**  
 □ 12×6 mm  
 ∅ 430 mm

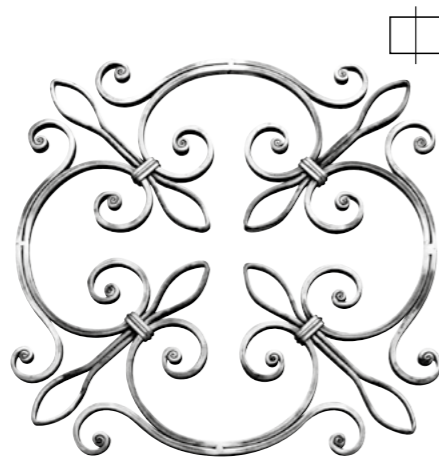

**R 1667/2**  
 □ 14×8 mm  
 ∅ 470 mm

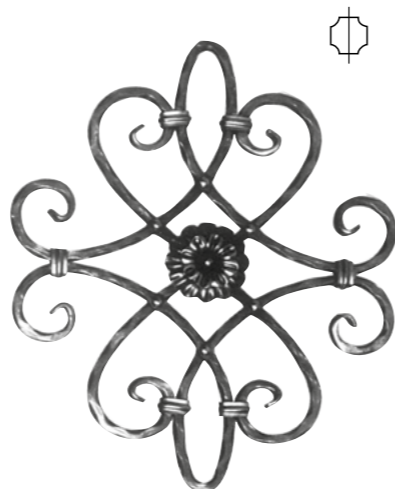

**R 26/C/1**  
 □ 12×12 mm  
 430×530 mm



**R 1647/1**  
 □ 12×6 mm  
 610×440 mm

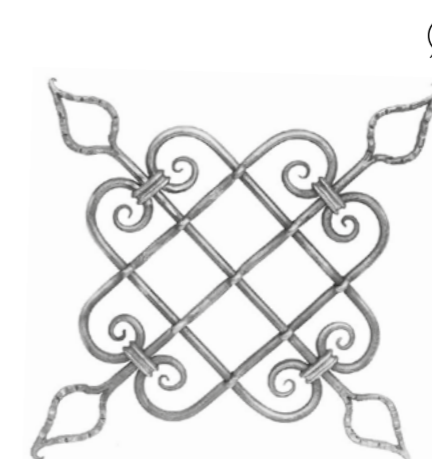

**R 679/1**  
 ∅ 12 mm  
 470×470 mm

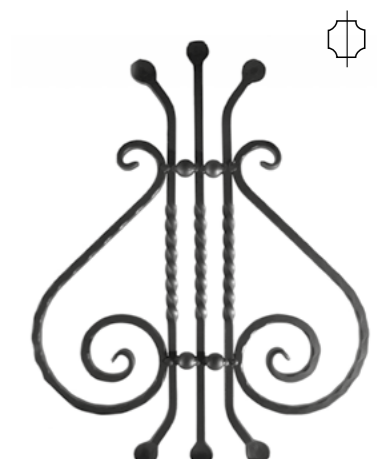

**R 460/2**  
 □ 12×12 mm  
 460×600 mm



**RN 0001**  
 □ 14×8 mm  
 ∅ 500 mm

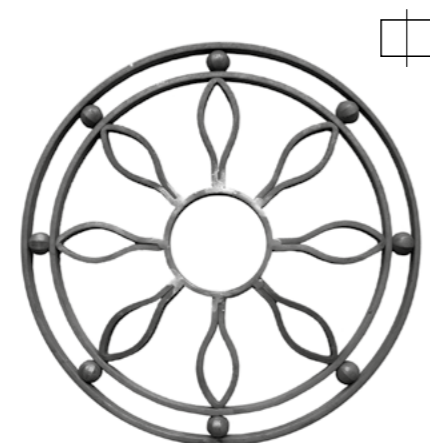

**R 1661/1**  
 □ 12×6 mm  
 ∅ 370 mm



**R 720/2**  
 □ 12×6 mm  
 ∅ 415 mm



**R 1647/3**  
 □ 12×6 mm  
 200×500 mm

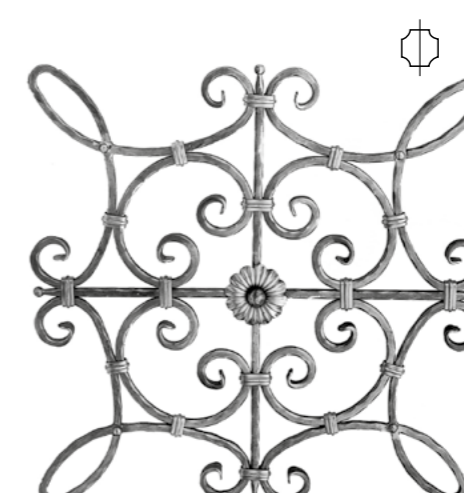

**R 480/1**  
 □ 12×12 mm  
 660×660 mm



**R 475/2**  
 □ 12×12 mm  
 380×900 mm

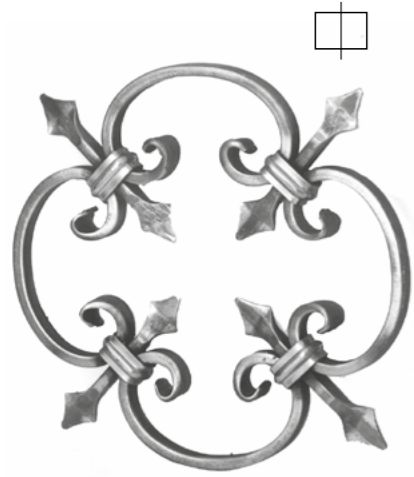

**R 21/5**  
 □ 14×8 mm  
 ∅ 275 mm

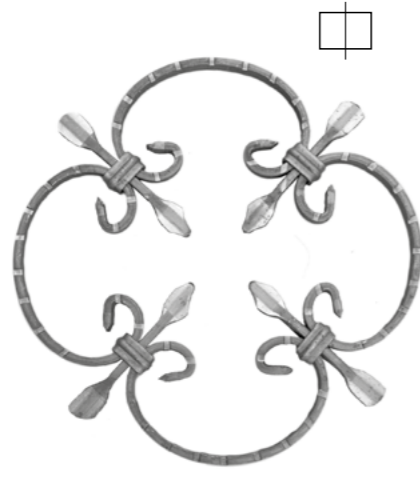

**R 23/1**  
 □ 10×5 mm  
 ∅ 250 mm



**R 23/2**  
 □ 20×4 mm  
 ∅ 250 mm

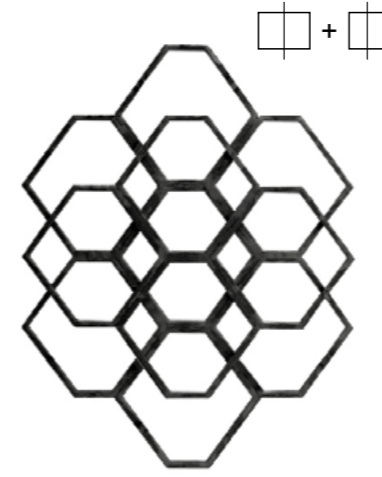

**RGD 299/4**  
 □ 16×8 mm + □ 8 mm  
 458×600 mm



**R 33/2**  
 □ 12×6 mm  
 250×250 mm

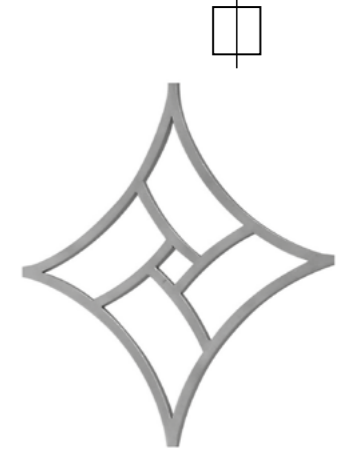

**RGD 211/2**  
 □ 12×12 mm  
 395×395 mm

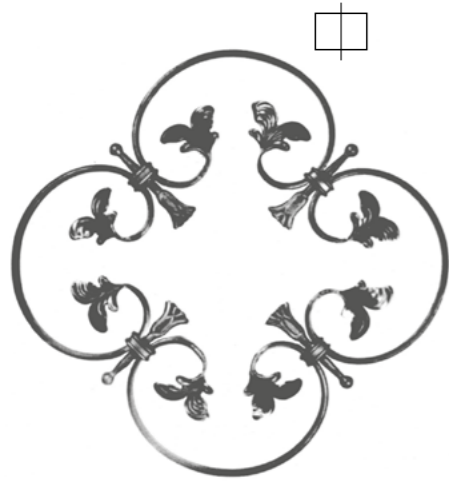

**R 24/B/1**  
 □ 12×6 mm  
 ∅ 460 mm

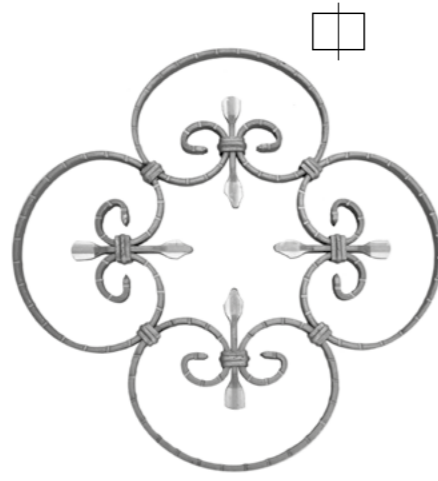

**R 24/1**  
 □ 10×5 mm  
 ∅ 380 mm

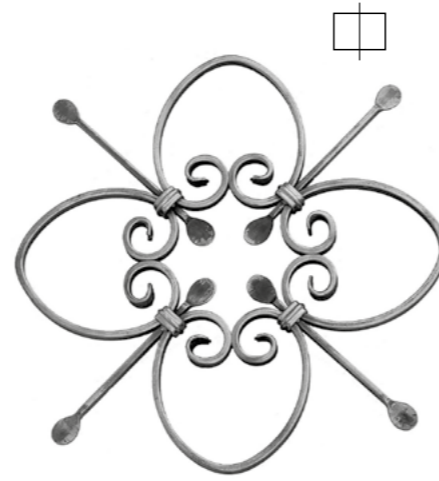

**R 1009/2**  
 □ 12×6 mm  
 ∅ 370 mm

□ 12x12 mm-es anyagra fűzhető



**RF 9325**  
 □ 12×6 mm  
 195x195 mm



**RF 9315**  
 □ 12×6 mm  
 155x105 mm



**RF 9316**  
 □ 12×6 mm  
 190x140 mm



**RF 9317**  
 □ 12×6 mm  
 190x140 mm



**RF 9319**  
 □ 12×6 mm  
 130x105 mm

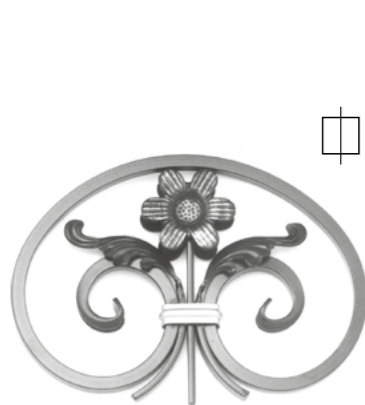

**R 24/F/2**  
 □ 12×12 mm  
 300×220 mm

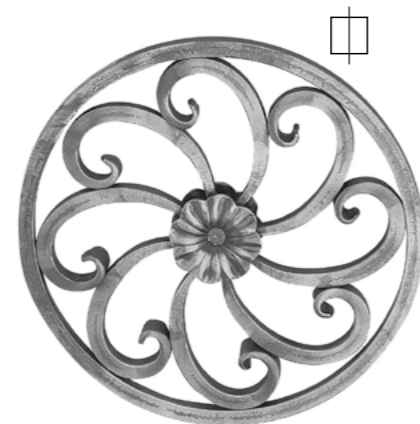

**R 1013/2**  
 □ 12×12 mm  
 ∅ 295 mm



**R 458/1**  
 □ 14×14 mm  
 300×210 mm

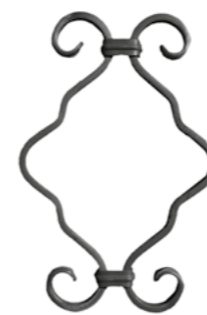

**RF 9320**  
 □ 12×6 mm  
 160x250 mm



**RF 9321**  
 □ 12×6 mm  
 170x290 mm



**RF 9322**  
 □ 12×6 mm  
 110x230 mm



**RF 9323**  
 □ 12×6 mm  
 240x480 mm



**R 35/1**  
 □ 12×6 mm  
 205×445 mm



**RF 9326**  
 □ 12×6 mm  
 170x350 mm



R 80/A/1	12×6 mm	110×270 mm
R 80/A/28	14×6 mm	110×270 mm
R 80/A/11	12×6 mm	65×150 mm
R 80/A/12	12×6 mm	70×190 mm
R 80/A/27	14×6 mm	70×190 mm



R 87/1	12×6 mm	80×130 mm
R 87/5	12×6 mm	90×160 mm
R 87/6	12×6 mm	80×150 mm
R 88/A/3	12×6 mm	70×110 mm
R 88/9	12×6 mm	125×250 mm

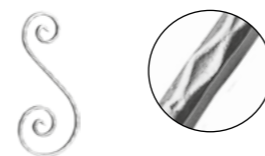

R 641/6	12×6 mm	120×290 mm
---------	---------	------------



R 641/1	12×6 mm	70×105 mm
---------	---------	-----------



R 74/2	12×6 mm	120×360 mm
--------	---------	------------



R 80/C/15	12×6 mm	80×290 mm
-----------	---------	-----------



R 641/8	12×6 mm	120×360 mm
---------	---------	------------



R 641/2	12×6 mm	70×130 mm
---------	---------	-----------



R 86/5	12×6 mm	95×210 mm
--------	---------	-----------



R 64/G/6	12×6 mm	50×230 mm
----------	---------	-----------



R 641/3	12×6 mm	60×115 mm
---------	---------	-----------



R 491/6	12×6 mm	∅ 100 mm
R 1319/16	12×6 mm	∅ 115 mm
R 1319/17	12×6 mm	∅ 130 mm



R 64/G/5	12×6 mm	60×105 mm
----------	---------	-----------



R 64/G/4	12×6 mm	60×105 mm
----------	---------	-----------

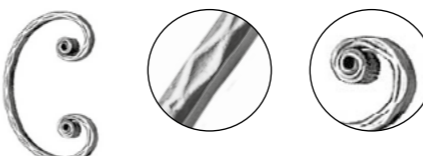

R 1296/7	12×6 mm	90×140 mm
----------	---------	-----------

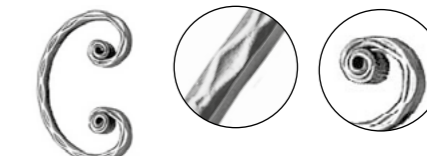

R 1296/8	12×6 mm	70×115 mm
----------	---------	-----------



R 80/A/3	12×6 mm	60×110 mm
R 80/A/29	14×6 mm	60×110 mm



R 80/A/13	12×6 mm	110×150 mm
R 80/A/30	14×6 mm	110×150 mm

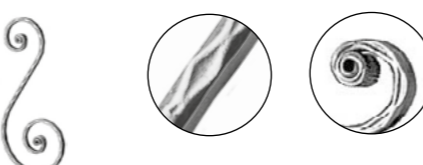

R 1296/3	12×6 mm	120×290 mm
----------	---------	------------

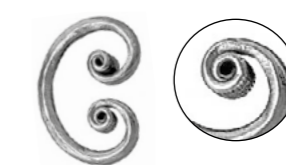

R 1296/13	∅ 12 mm	70×110 mm
-----------	---------	-----------



R 88/H/2	12×6 mm	75×150 mm
R 88/H/3	12×6 mm	75×130 mm
R 88/H/4	12×6 mm	75×160 mm
R 80/B/8	12×6 mm	75×120 mm



R 80/A/9	12×6 mm	70×105 mm
R 80/A/10	12×6 mm	95×140 mm
R 80/A/25	14×6 mm	95×140 mm



R 658/7	12×12 mm	80×130 mm
---------	----------	-----------



R 491/8	12×12 mm	∅ 100 mm
R 1317/1	12×12 mm	∅ 115 mm
R 1802/77	12×12 mm	∅ 120 mm
R 1317/2	12×12 mm	∅ 130 mm



R 92/B/3	12×6 mm	80×350 mm
----------	---------	-----------



R 64/G/3	12×6 mm	105×150 mm
----------	---------	------------



R 78/B/2	12×12 mm	110×220 mm
----------	----------	------------



**RN 0066**  
 □ 12×6 mm  
 90×140 mm

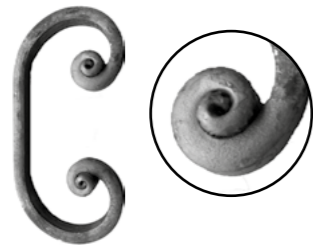

**RN 0068**  
 □ 12×6 mm  
 55×115 mm



**RN 0070**  
 □ 12×6 mm  
 120×360 mm



**RN 0073**  
 □ 12×6 mm  
 115×240 mm



**R 88/P/1**  
 □ 14×8 mm  
 130×290 mm



**R 88/E/5**  
 □ 12×6 mm  
 75×250 mm



**R 86/4**  
 □ 12×6 mm  
 75×220 mm



**R 76/1**  
 □ 12×6 mm  
 100×320 mm



**RF 9218/B**  
 □ 12×6 mm  
 110×270 mm



**RF 9218/J**  
 □ 12×6 mm  
 110×270 mm



**RGD 262/3**  
 □ 14×8 mm  
 100×230 mm



**RGD 262/4**  
 □ 14×8 mm  
 100×240 mm



**RGD 263/3**  
 □ 14×8 mm  
 100×220 mm



**RF 9309**  
 □ 12×6 mm  
 100×600 mm



**RF 9309/1**  
 □ 12×6 mm  
 100×600 mm

kovácsolt golyó

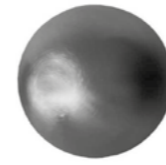

- R 117/1    ∅ 16
- R 116/F/1    ∅ 20
- R 116/F/2    ∅ 25
- R 116/F/3    ∅ 30
- R 123/1    ∅ 35
- R 116/F/4    ∅ 40
- R 116/F/5    ∅ 50
- R 116/F/6    ∅ 60
- R 116/F/7    ∅ 70
- R 116/F/8    ∅ 80
- R 116/F/9    ∅ 90
- R 116/F/10    ∅ 100



- R 1299/5    □ 12×6 mm    ∅ 100 mm
- R 1299/6    □ 12×6 mm    ∅ 130 mm



- CSAK A KÉSZLET EREJÉIG!**
- R 1803/1    □ 12×6 mm    ∅ 100 mm
  - R 1803/2    □ 12×6 mm    ∅ 115 mm
  - R 1803/3    □ 12×6 mm    ∅ 130 mm

üreges gömb furattal



anyagvastagsága: □ 2 mm

- R 1394/25    ∅ 25, furat ∅ 12,5 mm
- R 1394/24    ∅ 30, furat ∅ 12,5 mm
- R 1394/23    ∅ 40, furat ∅ 12,5 mm
- R 1394/22    ∅ 50, furat ∅ 12,5 mm
- R 1394/21    ∅ 60, furat ∅ 12,5 mm



- R 157/1    □ 12×6 mm    ∅ 100 mm
- R 157/2    □ 12×6 mm    ∅ 115 mm
- R 1802/25    □ 12×6 mm    ∅ 120 mm
- R 157/3    □ 12×6 mm    ∅ 130 mm



rovátkolt

- R 491/3    □ 12×6 mm    ∅ 100 mm
- R 491/4    □ 12×6 mm    ∅ 115 mm
- R 491/5    □ 12×6 mm    ∅ 130 mm





**R 116/A/19**  
Ø 55 mm



**R 116/A/20**  
Ø 55 mm



**R 1404/8**  
Ø 50 mm, H 75 mm  
□ 40×40 mm



**R 749/2**  
Ø 50 mm  
H 95 mm



**R 128/35**  
Ø 50 mm  
H 90 mm



**R 167/15**  
□ 30×30 mm



**R 113/10**  
70×130 mm

**R 167/16**  
□ 40×40 mm



**R 749/17** □ 25 mm, H 60 mm  
**R 749/18** □ 40 mm, H 85 mm  
**R 749/19** □ 60 mm, H 125 mm  
**R 749/20** □ 80 mm, H 150 mm



**R 749/7** Ø 28 mm, H 55 mm  
**R 749/8** Ø 43 mm, H 85 mm  
**R 749/9** Ø 55 mm, H 120 mm  
**R 749/10** Ø 70 mm, H 150 mm  
**R 749/11** Ø 90 mm, H 190 mm



**R 661/3**  
8 mm  
110×155 mm



**R 661/4**  
8 mm  
75×125 mm



**R 675/12**  
□ 3 mm  
80×110 mm



**R 675/13**  
□ 3 mm  
80×110 mm



**R 675/14**  
60×85 mm



**R 675/15**  
60×85 mm



**R 136/3**  
□ 3 mm  
70×60 mm



**R 136/4**  
□ 3 mm  
70×60 mm

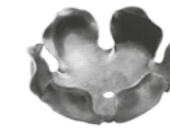

**R 136/5**  
□ 0,3 mm  
65×30 mm

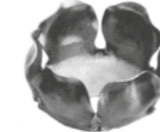

**R 136/6**  
□ 0,3 mm  
55×33 mm



**R 136/7**  
□ 0,3 mm  
38×40 mm



**R 136/1**  
□ 3 mm  
40×110 mm  
**R 136/13**  
□ 3 mm  
30×90 mm



**R 136/2**  
□ 3 mm  
40×110 mm  
**R 136/12**  
□ 3 mm  
30×90 mm

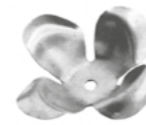

**R 136/9**  
□ 0,3 mm  
48×15 mm



**R 136/10**  
□ 3 mm  
70×160 mm



**R 136/11**  
□ 3 mm  
70×160 mm



**R 660/12**  
Ø 90 mm  
□ 4 mm



**CSAK A KÉSZLET  
EREJÉIG!**  
**R 140/6**  
□ 0,5 mm  
18×15 mm



**R 710/1**  
Ø 122×46 mm



**R 710/3**  
Ø 100×39 mm



**R 662/1**  
105×220 mm  
□ 16×8 mm



**R 662/2**  
105×220 mm  
□ 16×8 mm

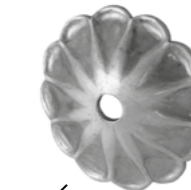

**R 697/1**  
Ø 90 mm  
□ 3 mm



**R 697/2**  
Ø 60 mm  
□ 3 mm

**R 138/8**  
28×60 mm  
□ 0,5 mm

**R 138/9**  
35×70 mm  
□ 0,5 mm

**R 138/10**  
45×85 mm  
□ 0,5 mm



**R 710/9**  
Ø 100×40 mm



**R 710/13**  
Ø 100×28 mm



**RF 9330**  
□ 2 mm  
Ø 90×10 mm



**RF 9329**  
□ 3 mm  
Ø 90 mm



**RF 9328**  
□ 4 mm  
60×60 mm



**R 689/5**  
Ø 12 mm  
120×220 mm



**R 689/6**  
Ø 12 mm  
120×220 mm



**R 692/8**  
□ 4 mm  
100×330 mm



**R 692/9**  
□ 4 mm  
50×180 mm



**R 40/B/12**  $\sphericalangle$  2 mm  $\varnothing$  48 mm  
**R 138/3**  $\sphericalangle$  2 mm  $\varnothing$  88×17 mm  
**R 138/4**  $\sphericalangle$  2 mm  $\varnothing$  90×10 mm  
**R 138/5**  $\sphericalangle$  0,3 mm  $\varnothing$  90×15 mm  
**R 138/6**  $\sphericalangle$  0,3 mm  $\varnothing$  50×10 mm  
**R 664/5**  $\sphericalangle$  3 mm  $\varnothing$  90 mm  
**R 138/13**  $\sphericalangle$  0,5 mm 190×195 mm



**R 675/8**  $\sphericalangle$  3 mm 60×85 mm  
**R 675/9**  $\sphericalangle$  3 mm 60×85 mm  
**R 675/10**  $\sphericalangle$  3 mm 80×110 mm  
**R 675/11**  $\sphericalangle$  3 mm 85×110 mm  
**R 702/1**  $\sphericalangle$  0,5 mm 62×110 mm  
**R 709/9**  $\sphericalangle$  0,3 mm 54×56 mm  
**R 709/11**  $\sphericalangle$  0,3 mm 72×72 mm



**R 702/2**  $\sphericalangle$  0,5 mm 52×65 mm  
**R 702/3**  $\sphericalangle$  0,5 mm 80×200 mm  
**R 94/B/6**  $\sphericalangle$  4 mm  $\varnothing$  115 mm  
**R 116/A/3**  $\sphericalangle$  3 mm  $\varnothing$  95 mm  
**R 116/A/4**  $\sphericalangle$  3 mm  $\varnothing$  65 mm  
**R 116/A/5**  $\varnothing$  95 mm

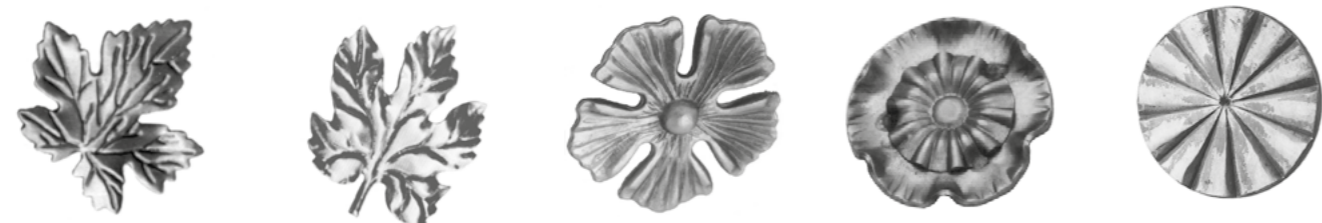

**R 138/11**  $\sphericalangle$  0,5 mm 75×70 mm  
**R 138/12**  $\sphericalangle$  0,5 mm 95×105 mm  
**R 138/14**  $\sphericalangle$  4 mm  $\varnothing$  120 mm  
**R 138/15**  $\sphericalangle$  2 mm  $\varnothing$  60 mm  
**R 654/5**  $\sphericalangle$  6 mm  $\varnothing$  60 mm

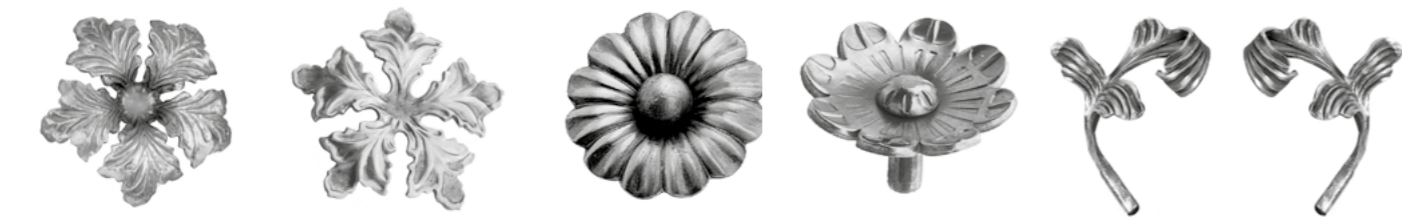

**R 665/1**  $\sphericalangle$  4 mm,  $\varnothing$  130 mm  
**R 665/2**  $\sphericalangle$  4 mm,  $\varnothing$  140 mm  
**R 665/4**  $\sphericalangle$  2 mm,  $\varnothing$  90 mm  
**R 665/6**  $\sphericalangle$  4 mm,  $\varnothing$  80 mm  
**R 697/3**  $\sphericalangle$  3 mm,  $\varnothing$  95 mm  
**R 697/4**  $\sphericalangle$  3 mm,  $\varnothing$  65 mm  
**R 676/2**  $\varnothing$  8×20 mm,  $\varnothing$  50 mm  
**R 676/3**  $\varnothing$  8×20 mm,  $\varnothing$  70 mm  
**R 94/B/11**  $\sphericalangle$  4 mm 180×130 mm  
**R 94/B/12**  $\sphericalangle$  4 mm 180×130 mm

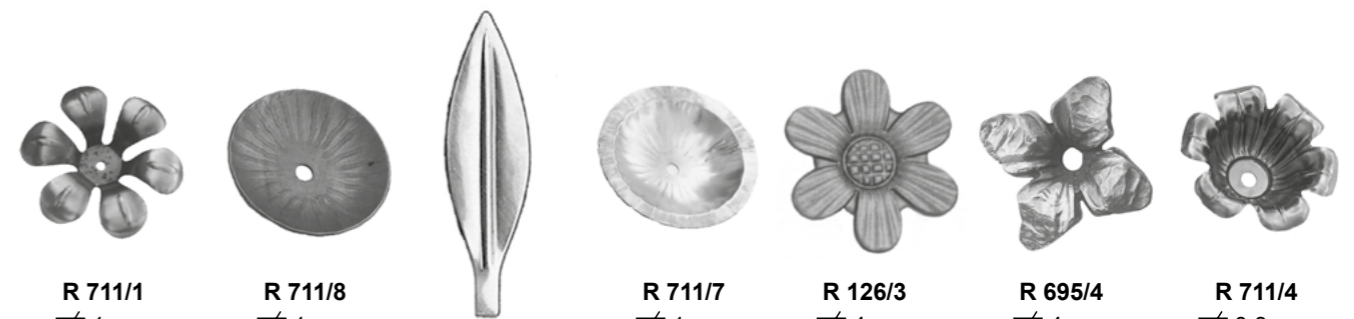

**R 711/1**  $\sphericalangle$  1 mm H 15 mm  $\varnothing$  85 mm  
**R 711/2**  $\sphericalangle$  1 mm H 10 mm  $\varnothing$  68 mm  
**R 711/8**  $\sphericalangle$  1 mm  $\varnothing$  97 mm H 19 mm  
**R 711/9**  $\sphericalangle$  1 mm  $\varnothing$  120 mm H 26 mm  
**R 711/7**  $\sphericalangle$  1 mm  $\varnothing$  140×25 mm  
**R 126/3**  $\sphericalangle$  4 mm  $\varnothing$  80 mm  
**R 695/4**  $\sphericalangle$  4 mm 60×60 mm  
**R 711/4**  $\sphericalangle$  0,3 mm  $\varnothing$  120×45 mm  
**R 709/13**  $\sphericalangle$  0,3 mm 18×68 mm



**R 711/6**  $\sphericalangle$  0,3 mm  $\varnothing$  150×28 mm  
**R 705/11**  $\varnothing$  45×12 mm  
**R 661/1**  $\sphericalangle$  16×8 mm 140×155 mm  
**R 661/2**  $\sphericalangle$  16×8 mm 140×155 mm  
**R 94/B/9**  $\sphericalangle$  4 mm 120×85 mm  
**R 94/B/10**  $\sphericalangle$  4 mm 120×85 mm



**R 1393/8**  $\varnothing$  90 mm  
**R 1393/9**  $\varnothing$  55 mm  
**R 756/14**  $\varnothing$  75 mm  
**R 662/3**  $\sphericalangle$  4 mm 65×130 mm  
**R 662/4**  $\sphericalangle$  4 mm 65×130 mm  
**R 666/2** 55×90 mm  $\sphericalangle$  4 mm  
**R 139/6** 28×70 mm  $\sphericalangle$  0,5 mm

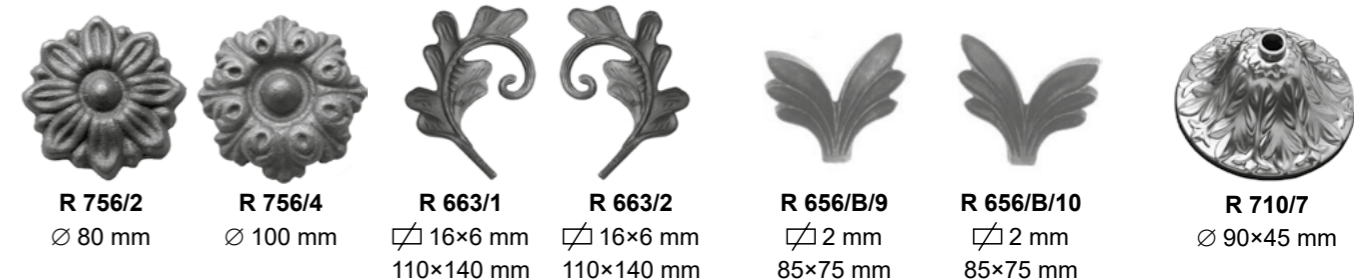

**R 756/2**  $\varnothing$  80 mm  
**R 756/4**  $\varnothing$  100 mm  
**R 663/1**  $\sphericalangle$  16×6 mm 110×140 mm  
**R 663/2**  $\sphericalangle$  16×6 mm 110×140 mm  
**R 656/B/9**  $\sphericalangle$  2 mm 85×75 mm  
**R 656/B/10**  $\sphericalangle$  2 mm 85×75 mm  
**R 710/7**  $\varnothing$  90×45 mm



**R 656/B/7**  $\sphericalangle$  2 mm 50×125 mm  
**R 656/B/8**  $\sphericalangle$  2 mm 50×125 mm  
**R 137/1** 80×160 mm  $\sphericalangle$  1 mm  
**R 137/2** 80×160 mm  $\sphericalangle$  1 mm  
**R 663/5** 115×180 mm  $\varnothing$  12 mm  
**R 663/6** 115×180 mm  $\varnothing$  12 mm  
**R 705/13**  $\varnothing$  45×10 mm

CSAK A KÉSZLET EREJÉIG!



**R 126/1**  
□ 10 mm  
H 140 mm



**R 126/8**  
∅ 20 mm  
60×115 mm



**CSAK A KÉSZLET  
EREJÉIG!**  
**R 126/C/9**  
∅ 40 mm  
80×150 mm



**R 126/B/6**  
∅ 20 mm  
45×80 mm



**R 750/1**  
∅ 14 mm  
H 150 mm



**R 731/5**  
□ 12 mm  
23×110 mm

**R 731/6**  
□ 16 mm  
25×110 mm



**R 126/19**  
∅ 25 mm  
H 140 mm



**R 732/1**  
□ 12 mm  
25×135 mm



**R 727/6**  
∅ 24 mm  
60×160 mm



**R 733/3**  
□ 12 mm  
23×110 mm

**R 733/4**  
□ 16 mm  
25×110 mm



**R 735/1**  
□ 14 mm  
70×140 mm



**R 735/2**  
□ 14 mm  
20×115 mm



**R 727/9**  
□ 25 mm  
70×120 mm



**R 126/C/8**  
□ 12 mm  
H 100 mm



**R 1855/4**  
∅ 12 mm  
135×60 mm



**R 1855/5**  
∅ 12 mm  
135×60 mm

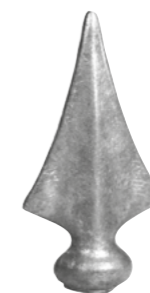

**R 125/1**  
∅ 35 mm  
H 140 mm



**R 125/2**  
□ 14 mm  
H 140 mm



**R 1855/10**  
∅ 30 mm  
H 170 mm



**R 1385/1**  
□ 12 mm  
30×150 mm



**R 128/D/7**  
□ 12 mm  
H 220 mm



**R 129/8**  
□ 12 mm  
H 200 mm



**R 129/12**  
□ 12 mm  
H 200 mm



**R 126/B/4**  
∅ 20 mm  
70×130 mm

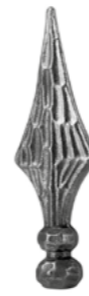

**R 1855/6**  
∅ 26 mm  
48×150 mm



**CSAK A KÉSZLET  
EREJÉIG!**  
**R 1855/8**  
∅ 40 mm  
220 mm



**R 727/11**  
∅ 30 mm  
35×120 mm



**R 124/7**  
∅ 14 mm  
H 127 mm



**CSAK A KÉSZLET  
EREJÉIG!**  
**R 120/3/SC**  
∅ 30 mm  
H 165 mm

**NEM ÖNTÖTT!  
KOVÁCSOLT!**



**R 124/1**  
∅ 12 mm  
60×125 mm  
**R 124/2**  
∅ 15 mm  
H 160 mm  
**CSAK A KÉSZLET  
EREJÉIG!**  
**R 124/9**  
∅ 20 mm  
H 190 mm



**R 124/3**  
∅ 12 mm  
H 125 mm  
**CSAK A KÉSZLET  
EREJÉIG!**  
**R 124/5**  
∅ 20 mm  
H 190 mm



**R 126/2**  
□ 20 mm,  
H 130 mm  
**R 126/15**  
□ 30 mm,  
H 160 mm  
**R 126/16**  
□ 40 mm,  
H 190 mm



**CSAK A KÉSZLET  
EREJÉIG!**  
**R 727/1**  
∅ 32 mm  
70×140 mm

**R 727/3**  
∅ 25 mm  
55×110 mm



**CSAK A KÉSZLET  
EREJÉIG!**  
**R 126/B/1**  
∅ 19 mm  
82×195 mm  
**R 126/B/2**  
∅ 16 mm  
68×160 mm

**R 126/B/3**  
∅ 13 mm  
54×130 mm



**R 126/9**  
∅ 20 mm  
H 90 mm

**R 726/4**  
∅ 24 mm  
H 125 mm



**RF 9203**  
□ 80×80 mm  
H 175 mm



**RF 9202**  
□ 100×100 mm  
H 190 mm



**RF 9212**  
□ 100×100 mm  
H 180 mm



**R 1766/42**  
□ 30 mm  
H 300 mm



**RF 9215**  
□ 80×80 mm  
H 80 mm



**R 178/22**  
□ 30 mm

**R 178/30**  
□ 40 mm



**RF 9401**  
□ 12×12 mm  
H 1140 mm



**RF 9401/1**  
□ 12×12 mm  
H 1140 mm



**RF 9402**  
□ 12×12 mm  
H 1070 mm



**RF 9405**  
□ 12×12 mm  
H 1140 mm



**RF 9407**  
□ 12×12 mm  
H 1140 mm



**RF 9204**  
□ 40×40 mm  
H 45 mm

**RF 9205**  
□ 50×50 mm  
H 55 mm

**RF 9206**  
□ 60×60 mm  
H 65 mm

**RF 9207**  
□ 80×80 mm  
H 90 mm

**RF 9208**  
□ 100×100 mm  
H 100 mm

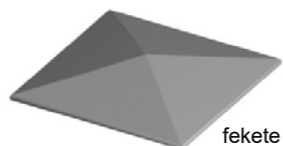

fekete

Rendelési szám	Mérete
R438	40×40 mm
R439	50×50 mm
R138.1	60×60 mm
R139	80×80 mm
R140	100×100 mm
R141	120×120 mm

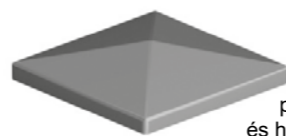

peremezett és horganyzott

Rendelési szám	Mérete
R185/Z/cink	30×30 mm
R186/Z/cink	40×40 mm
R187/Z/cink	50×50 mm
R188/Z/cink	60×60 mm
R189/Z/cink	80×80 mm
R190/Z/cink	100×100 mm



**RF 9214**  
□ 12×6 mm  
Hossz: 430 mm



**RF 9219**  
□ 12×6 mm  
Hossz: 540 mm



**RF 9220**  
□ 12 mm  
Hossz: 445 mm



**RF 9213**  
□ 12×6 mm  
Hossz: 740 mm



**RF 9221**  
∅ 12 mm  
Hossz: 410 mm



- R 227/29 Aranypatina
- R 227/30 Rézpatina
- R 227/31 Zöldpatina
- R 227/32 Ezüstpatina
- R 227/50 Zöld rézpatina
- R 227/51 Fakó aranypatina
- R 227/52 Antik aranypatina

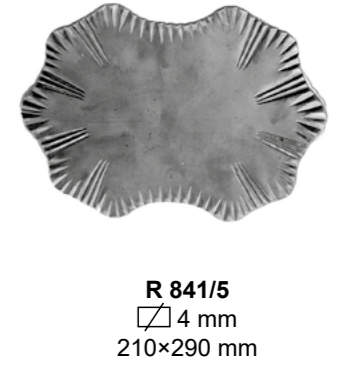
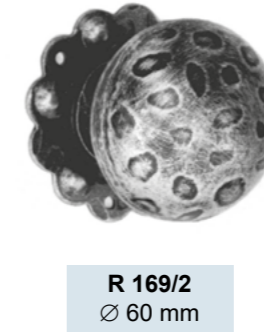
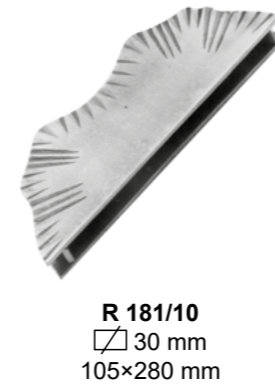

**R 185/9**  
Horganyspray

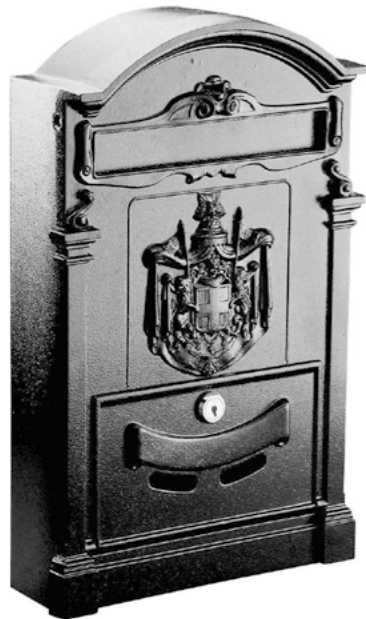
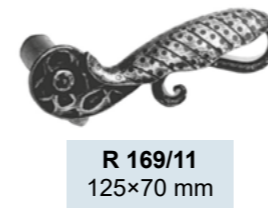

**R 849/2**  
255×90×405 mm

Alumínium postaláda  
fekete színű

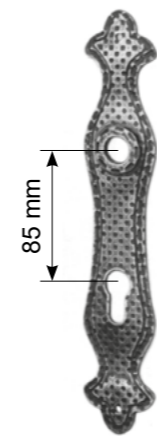

**R 169/8**  
265×48 mm

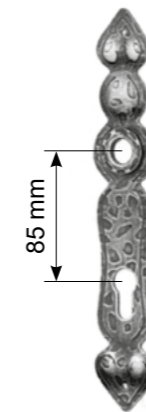

**R 169/9**  
265×48 mm



**R 169/10**  
250×38 mm



**RF 9301**  
90×320 mm



R 851/1-2-3-4-5-6-7-8-9-10  
80×40×3 mm



R 171/1-2-3-4-5-6-7-8-9-10  
H 120 mm

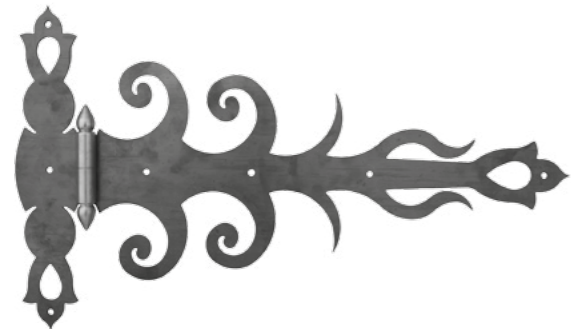

RF 9339/B 700×420×4 mm balos  
RF 9339/J 700×420×4 mm jobbos  
RF 9337/B 470×280×4 mm balos  
RF 9337/J 470×280×4 mm jobbos



RF 9340 600×280×4 mm  
RF 9338 400×185×4 mm



Levélbedobó

RF 9343  
385x110 mm



Levélbedobó

RF 9344  
280x135 mm

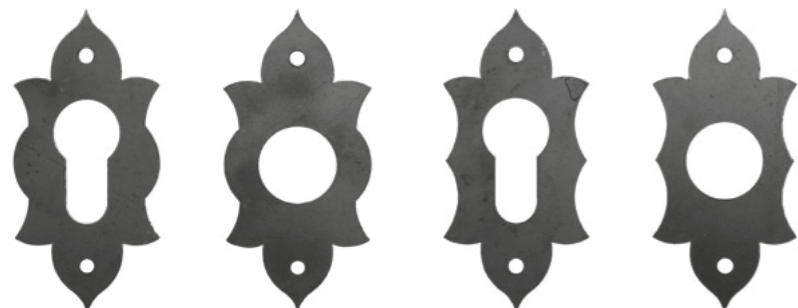

RF 9333 40×80×2 mm  
RF 9334 40×80×2 mm  
RF 9331 40×80×2 mm  
RF 9332 40×80×2 mm

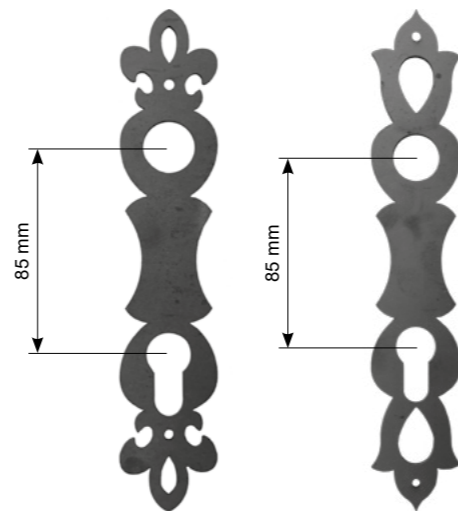

RF 9335 40×205×2 mm  
RF 9336 40×225×2 mm



R 158/1  
14×4×4000 mm



R 158/3  
14×4×4000 mm



R 158/5  
11×3×4000 mm



R 1839/25  
16×3×4000 mm

R 158/2  
18×6×4000 mm

R 158/4  
18×5×4000 mm

R 158/6  
14×4×4000 mm

R 158/49  
25×8×3000 mm

R 158/50  
30×8×3000 mm

R 158/51  
40×8×300 mm

RF 9304  
1db 12×12 mm-es  
14×4 mm-es

RF 9304/1  
1db 14×14 mm-es  
14×4 mm-es

RF 9304/2  
1 db 12×12+1 db 12×6 mm-es  
14×4 mm-es

RF 9304/3  
1 db 12×12+2 db 12×6 mm-es  
14×4 mm-es

RF 9304/4  
1 db 20×20 mm-es  
18×6 mm-es

RF 9304/5  
1 db 25×25 mm-es  
18×6 mm-es

RF 9304/6  
1 db 30×30 mm-es  
18×6 mm-es



RF 9304/7  
1 db 12×12 mm-es  
14×4 mm-es

RF 9304/8  
1 db 14×14 mm-es  
14×4 mm-es

RF 9304/9  
1db 12×12+1db 12×6 mm-es  
14×4 mm-es

RF 9304/10  
1db 12×12+2 db 12×6 mm-es  
14×4 mm-es

RF 9304/11  
1 db 20×20 mm-es  
18×5 mm-es

RF 9304/12  
1 db 25×25 mm-es  
18×5 mm-es

RF 9304/13  
1 db 30×30 mm-es  
18×5 mm-es

Élbordázott  
laposacél

**R 118/7**  
20×8×3000 mm

**RR 1838/5/6**  
25×5×6000 mm

**RR 1838/7/6**  
30×6×6000 mm

**R 114/9/6**  
30×8×6000 mm

**RR 114/81/6**  
40×6×6000 mm

**R 1838/2/6**  
40×8×6000 mm

**R 1838/3**  
50×8×3000 mm

Élbordázott  
négyzetacél

**R 118/1**  
12×3000 mm

**R 118/1/6**  
12×6000 mm

**R 118/2**  
14×3000 mm

**R 118/2/6**  
14×6000 mm

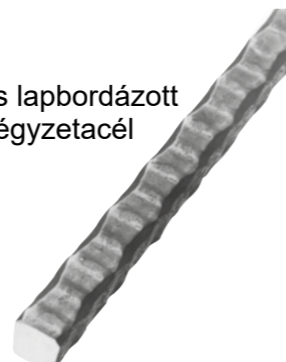
Él- és lapbordázott  
négyzetacél

**R 118/A/1**  
12×3000 mm

Nútot  
négyzetacél

**R 625/3**  
12×3000 mm

Élbordázott  
zártszelvény

**RR 118/E/1**  
16×1,5×6000 mm

**RR 118/E/2**  
20×2,5×6000 mm

**RR 118/E/9**  
25×2,5×6000 mm

**RR 118/E/3**  
30×2,5×6000 mm

**RR 118/E/5**  
40×2,5×6000 mm

**RR 1374/15**  
50×2,5×6000 mm

**RR 1374/17**  
60×2,5×6000 mm

**R 1374/16**  
80×2,7×6000 mm

Élbordázott  
és lapcsíkozott  
laposacél

**R 1839/11**  
30×6×3000 mm

**R 1839/13**  
40×6×3000 mm

Él- és lapbordázott  
laposacél

**R 118/A/6**  
30×8×3000 mm

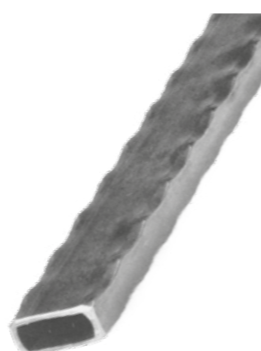
Élbordázott  
zártszelvény

**R 118/E/4**  
40×20×2,5×6000 mm

**R 118/E/8**  
80×40×2,7×6000 mm

**RR 118/E/7**  
60×40×2,5×6000 mm

Megmun-  
kátlan  
laposacél

**R 1368/12**  
12×6×3000 mm

**R 1368/41**  
14×6×3000 mm

**R 1368/13**  
14×8×3000 mm



**R 623/1**  
12×6×3000 mm

**R 623/3**  
14×6×3000 mm

Élmintás laposacél



**R 1839/21**  
12×6×3000 mm

**R 1839/22**  
14×6×3000 mm

Élbordázott laposacél



**R 114/A/5**  
30×5×3000 mm

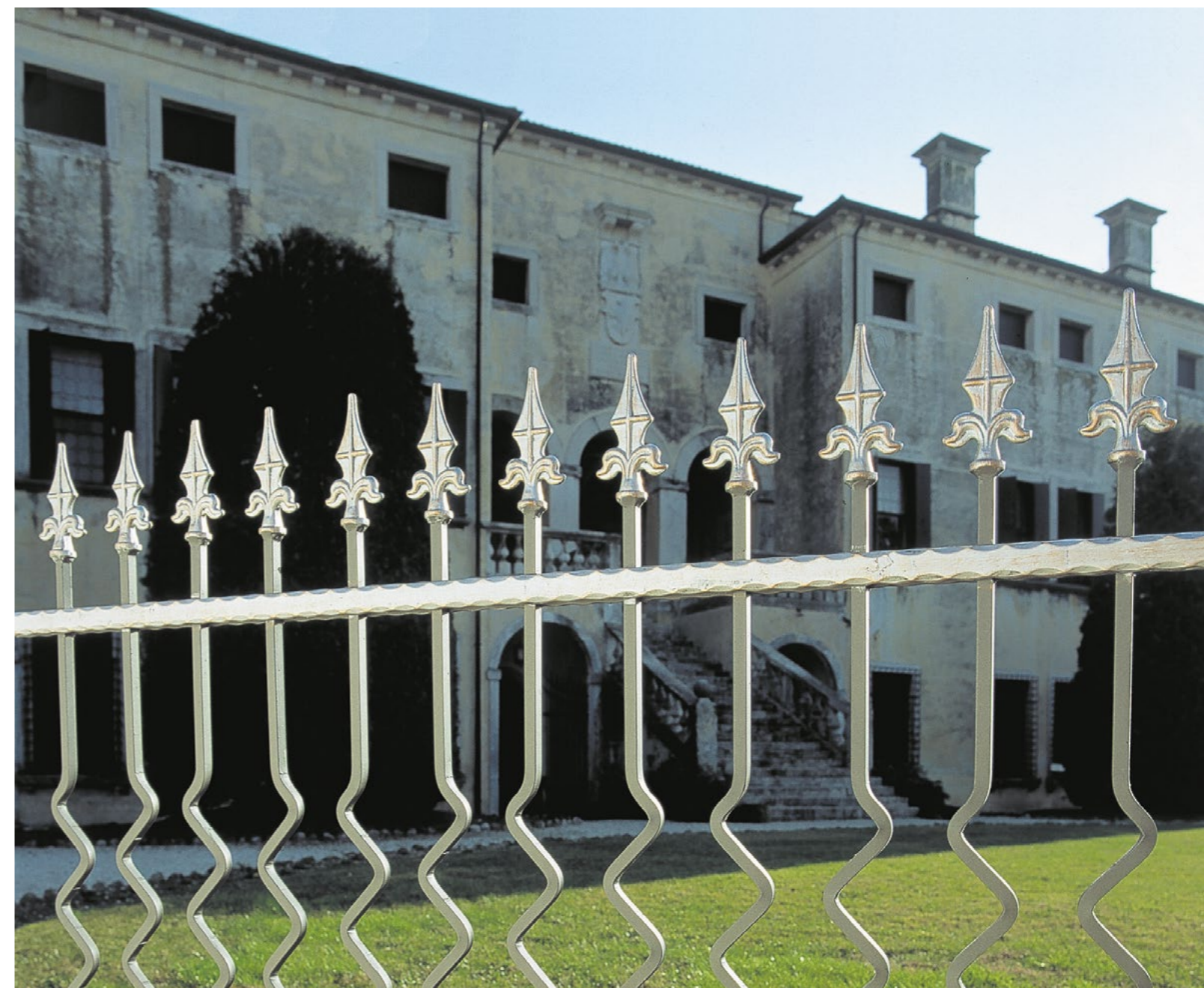



faerezet  
hatású felület

- R 599/1**  
Ø 8×3000 mm
- R 599/2**  
Ø 10×3000 mm
- R 599/3**  
Ø 12×3000 mm
- R 599/4**  
Ø 14×3000 mm
- R 599/9**  
Ø 24×3000 mm



- R 1360/6**  
Ø 12×2000 mm  
furat: Ø 12×120 mm

- R 42/A/1**  
Ø 14×2000 mm  
furat: Ø 14×100 mm
- Lyukasztott köracél



- R 1834/1**  
∇ 32×5×3000 mm



- R 1834/2**  
∇ 31×5×3000 mm

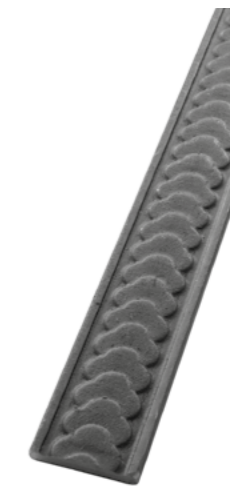

- R 1834/3**  
∇ 31×5×3000 mm



- R 1834/4**  
∇ 31×5×3000 mm



- R 1834/6**  
∇ 31×9×3000 mm



- R 1834/9**  
∇ 32×6×3000 mm



- R 1838/8**  
∇ 30×5×3000 mm



- R 1834/5**  
∇ 32×9×3000 mm



- R 1360/1**  
∇ 12×2000 mm  
furat: ∇ 12×120 mm

- R 1360/2**  
∇ 14×2000 mm  
furat: ∇ 14×140 mm

Élmángorolt  
lyukasztott  
négyzetacél



- R 1360/7**  
∇ 12×2000 mm  
furat: ∇ 12×120 mm

- R 42/A/5**  
∇ 14×2000 mm  
furat: ∇ 14×110 mm

Lyukasztott  
négyzetacél



- R 180/49**  
∇ 40×6×2500 mm



**R 114/5**  
40×8×3000 mm



**R 114/12**  
40×8×3000 mm



**R 1837/6**  
30×6×3000 mm

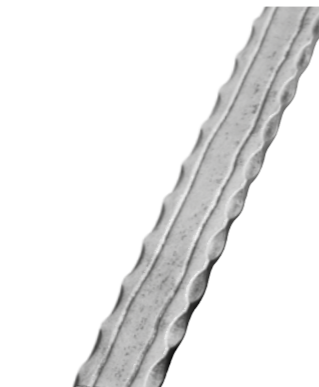

**R 114/10**  
40×8×3000 mm



**R 810/B/1/T**  
35×9×3000 mm

**R 114/5/6**  
40×8×6000 mm

**R 114/12/6**  
40×8×6000 mm

**R 114/A/1**  
43×7×3750 mm

**R 114/10/6**  
40×8×6000 mm



**R 114/A/3**  
50×14×3000 mm



**R 1373/4**  
40×11×3000 mm



**R 811/4/T**  
41×11×3000 mm



**R 811/5/T**  
50×14×3000 mm



**R 158/10/C**  
30×8×3000 mm

**R 114/A/3/6**  
50×14×6000 mm

**R 811/7/T**  
41×11×6000 mm

**R 158/12/C**  
40×11×3000 mm



**R 114/B/13**  
114/A/3-hez

**R 116/10**  
114/5-höz

**R 116/14**  
114/10-hez

**R 116/16**  
114/12-höz

**R 812/6**  
158/12/C-hez

**R 812/13/T**  
811/4/T-hez

**R 812/15/T**  
811/5/T-hez

**R 1377/14/T**  
810/B/1/T-hez

**R 1817/9**  
1373/4-hez

**R 1818/11**  
114/9-hez

**R 1818/12**  
1838/2-höz

**R 1818/15**  
114/A/1-hez



**R 114/B/14**  
114/A/3-hez

**R 116/2**  
114/5-höz

**R 116/6**  
114/10-hez

**R 116/8**  
114/12-höz

**R 812/2**  
158/12/C-hez

**R 1377/41/T**  
811/4/T-hez

**R 1377/42/T**  
811/5/T-hez

**R 1377/1/T**  
810/B/1/T-hez

**R 1817/5**  
1373/4-hez

**R 1818/7**  
114/9-hez

**R 1818/8**  
1838/2-höz

**R 114/B/1**  
114/A/1-hez

**Korláttető rögzítő elemek, oldalfalra.**



**RF 9302**  
90×170 mm



**RF 9305**  
90×150 mm



**RF 9303**  
90×230 mm



**R 94/A/2**  
160×95 mm



**R 1814/17**  
1373/4-hez

**R 1814/18**  
114/A/3-hez



**R 1814/11**  
1373/4-hez

**R 1814/12**  
114/A/3-hez



**R 1817/9/S5**  
1373/4-hez

**R 114/B/13/S9**  
114/A/3-hez

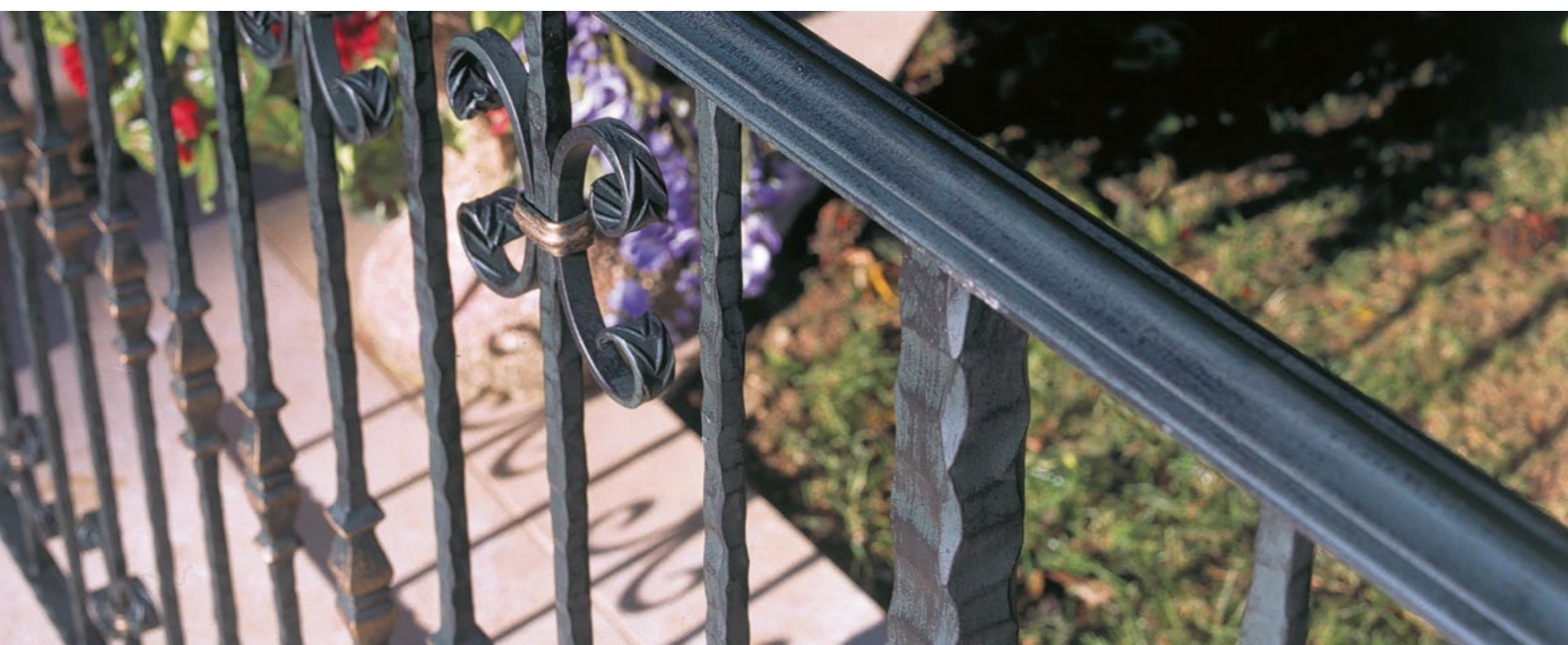

• ROZSDAMENTES •

• ROZSDAMENTES • SZÁLCSISZOLT •

	Cikkszám	Méret
AISI 304	RE001/6000	Ø 42,4x2,0x6000 mm
	RFE001/1000	Ø 42,4x2,0x1000 mm
	RFE001/1200	Ø 42,4x2,0x1200 mm
	RFE001/1500	Ø 42,4x2,0x1500 mm
	RFE001/2000	Ø 42,4x2,0x2000 mm
	RFE001/3000	Ø 42,4x2,0x3000 mm
	RFE001/4000	Ø 42,4x2,0x4000 mm



	Cikkszám	Méret
AISI 304	RE005/6000	Ø 12,0x6000 mm
	RFE005/3000	Ø 12,0x3000 mm



**ÁLLÍTHATÓ SZÁRRAL**

RE031/S1  
Ø 42,4x2,0 mm-es cső részére

RE510/424  
Ø 42,4x2,0 mm-es cső részére

RE0102  
Ø 42,4x2,0 mm-es cső részére

RE030/S  
Ø 42,4x2,0 mm-es cső részére

RE500/424  
Ø 42,4x2,0 mm-es cső részére

RE0104  
Ø 42,4x2,0 mm-es cső részére

AISI 303: csak vízzel és vízgőzzel szemben korrózióálló!

AISI 304: csak vízzel és vízgőzzel szemben korrózióálló!

AISI 316: vízzel, savval, lúggal, klórral és azok gőzeivel szemben korrózióálló!

- Ragasztva
- Gumival kalapálva
- Csavarozva
- Hegesztve

<p>RE450/304 Ø 42,4x2,0 mm-es cső részére</p>	<p>RE451/304 Ø 42,4x2,0 mm-es cső részére</p>	<p>RE4483 Ø 42,4x2,0 mm-es cső részére</p>	<p>Szög váltás térben</p> <p>RE4471/304 Ø 42,4x2,0 mm-es cső részére</p>	<p>Szög váltás síkban</p> <p>RE5587/304 Ø 42,4x2,0 mm-es cső részére</p>
<p>RE0696 Ø 42,4x2,0 mm-es cső részére</p>	<p>RE116200 Ø 42,4x2,0 mm-es cső részére</p>	<p>RE113 Ø 42,4x2,0 mm-es cső részére</p>	<p>RE0127 Ø 25 mm zsákfurat Ø 12,2 mm</p>	<p>RE0069 Ø 42,4x2,0 mm-es cső részére Furat: Ø 12,2 mm</p>
<p>RE020 Ø 42,4x2,0 mm-es cső részére</p>	<p>RE0223 Ø 42,4x2,0 mm-es cső részére</p>	<p>RE036400 Ø 42,4x2,0 mm-es cső részére</p>	<p>RE4566 Ø 42,4x2,0 mm-es cső részére</p>	<p>RE4561 Ø 42,4x2,0 mm-es cső részére</p>
<p>90°-OS ALÁTÉT</p> <p>RE011971 Ø 42,4x2,0 mm-es cső részére</p>	<p>RE481 Ø 42,4x2,0 mm-es cső részére</p>	<p>RE01112 Ø 42,4x2,0 mm-es cső részére</p>	<p>RE0119 Ø 42,4x2,0 mm-es cső részére</p>	<p>RE455/304 Ø 42,4x2,0 mm-es cső részére</p>

• ROZSDAMENTES •

	Cikkszám	Méret
AISI 304	RE06204040	□ 40,0x40,0x2,0x6000 mm
	RFE062040/900	□ 40,0x40,0x2,0x900 mm
	RFE062040/1100	□ 40,0x40,0x2,0x1100 mm

	Cikkszám	Méret
AISI 304	RE005/6000	∅ 12,0x6000 mm
	RFE005/3000	∅ 12,0x3000 mm

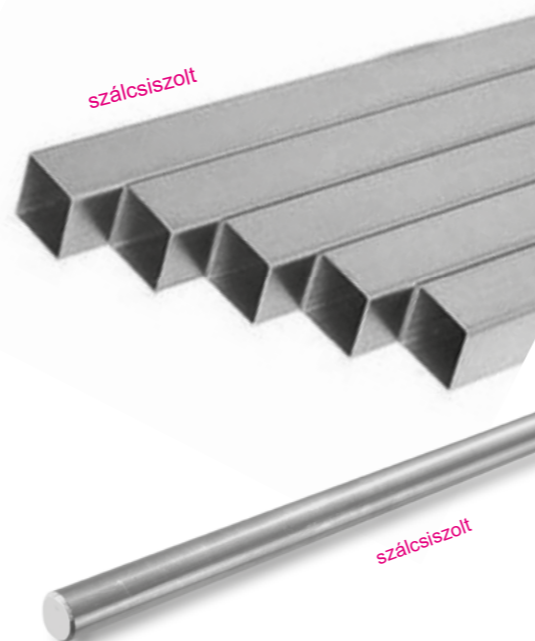

RE037600	RE037400	RE037200	RE037800	RE4230
□ 40,0x2,0 mm-es zártszelvényhez	□ 40,0x2,0 mm-es zártszelvényhez	□ 40,0x2,0 mm-es zártszelvényhez	□ 40,0x2,0 mm-es zártszelvényhez	□ 40,0x2,0 mm-es zártszelvényhez

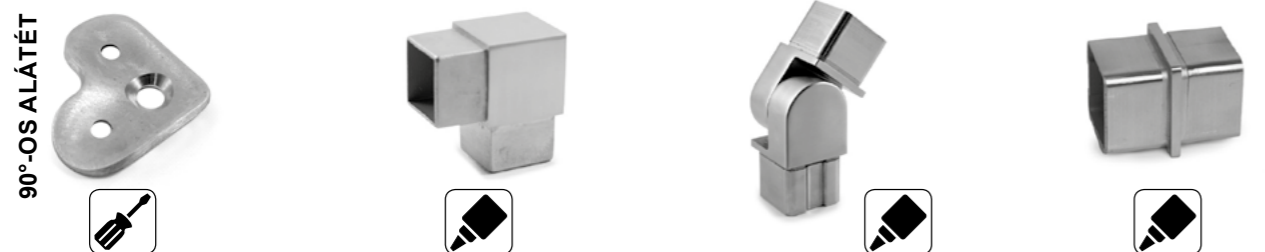

RE011970	RE4713/304	RE4743	RE4760/304
□ 40,0x2,0 mm-es zártszelvényhez	□ 40,0x2,0 mm-es zártszelvényhez	□ 40,0x2,0 mm-es zártszelvényhez	□ 40,0x2,0 mm-es zártszelvényhez

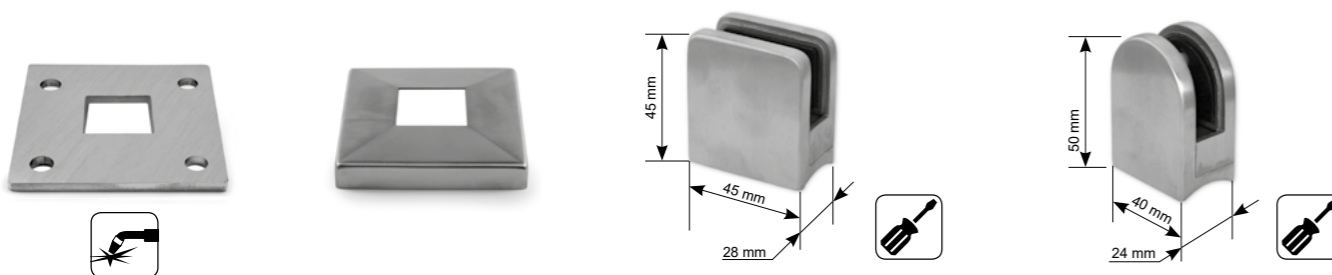

Cikkszám	Csatlakozás	Üveg méret	Cikkszám	Csatlakozás	Üveg méret
RE 1 11 000 08	zártszelvény	8 mm	RE 1 10 042 08	∅ 42,4 mm cső	8 mm
RE 1 11 000 10	zártszelvény	10 mm	RE 1 16 042 10	∅ 42,4 mm cső	10 mm

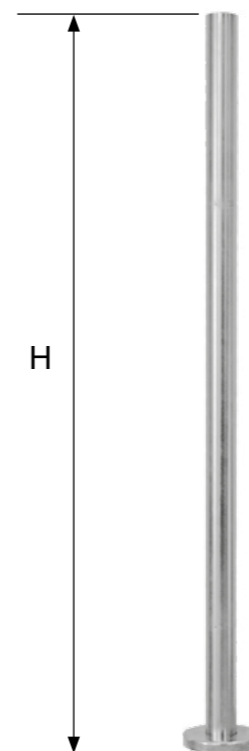

AISI 304	Cikkszám	Méret	H
	RFE0171	∅ 42,4 mm	1000 mm

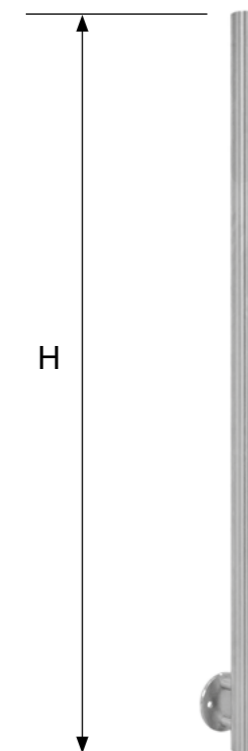

AISI 304	Cikkszám	Méret	H
	RFE0173	∅ 42,4 mm	1200 mm

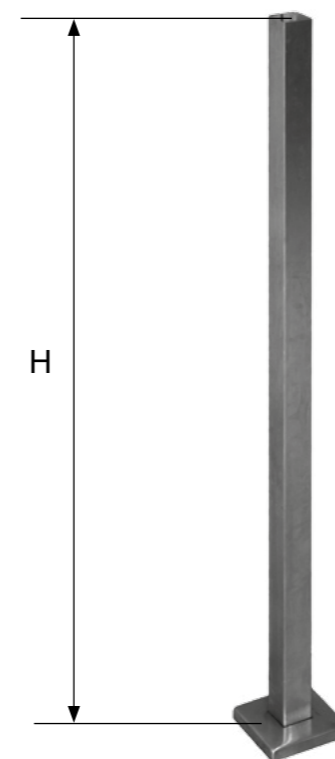

AISI 304	Cikkszám	Méret	H
	RFE0177	□ 40,0 mm	900 mm

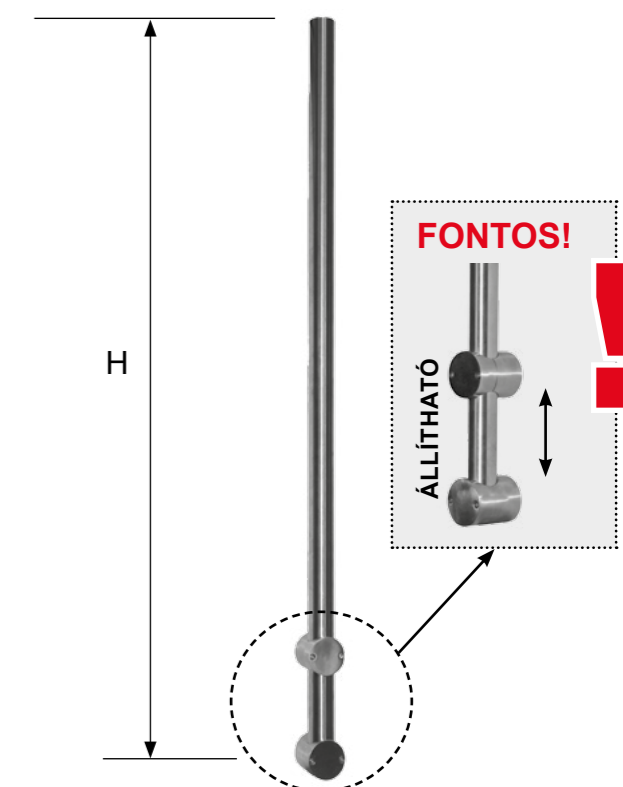

AISI 304	Cikkszám	Méret	H
	RFE0288	∅ 42,4 mm	1200 mm

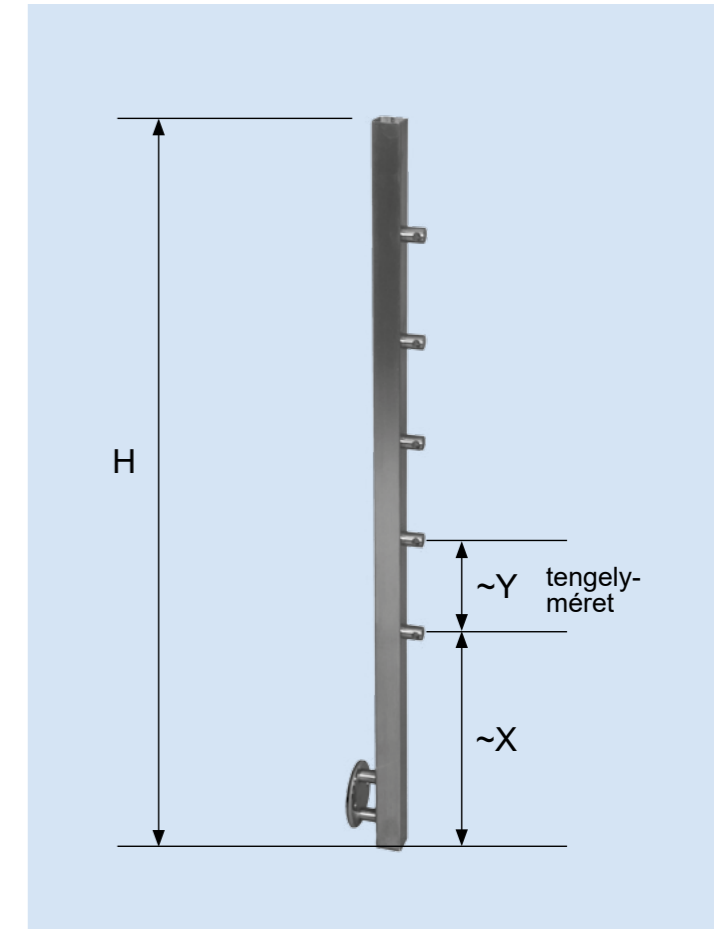
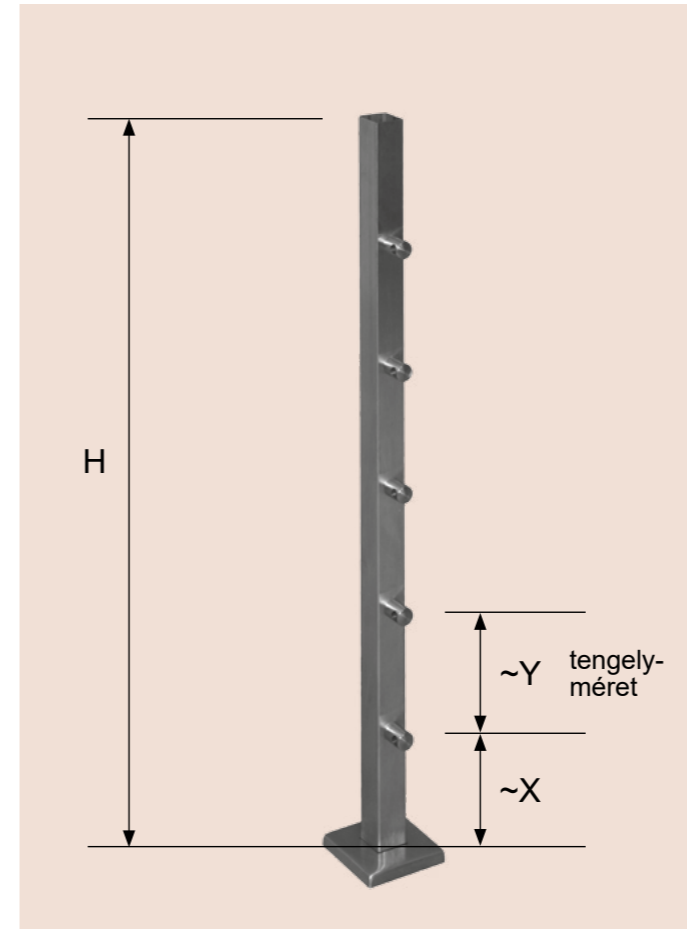
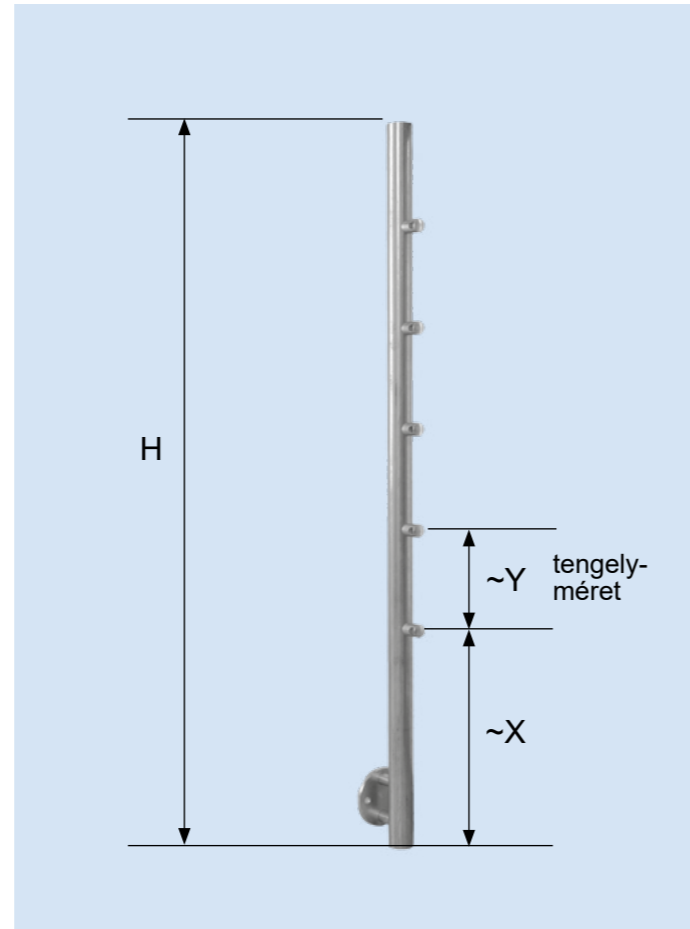
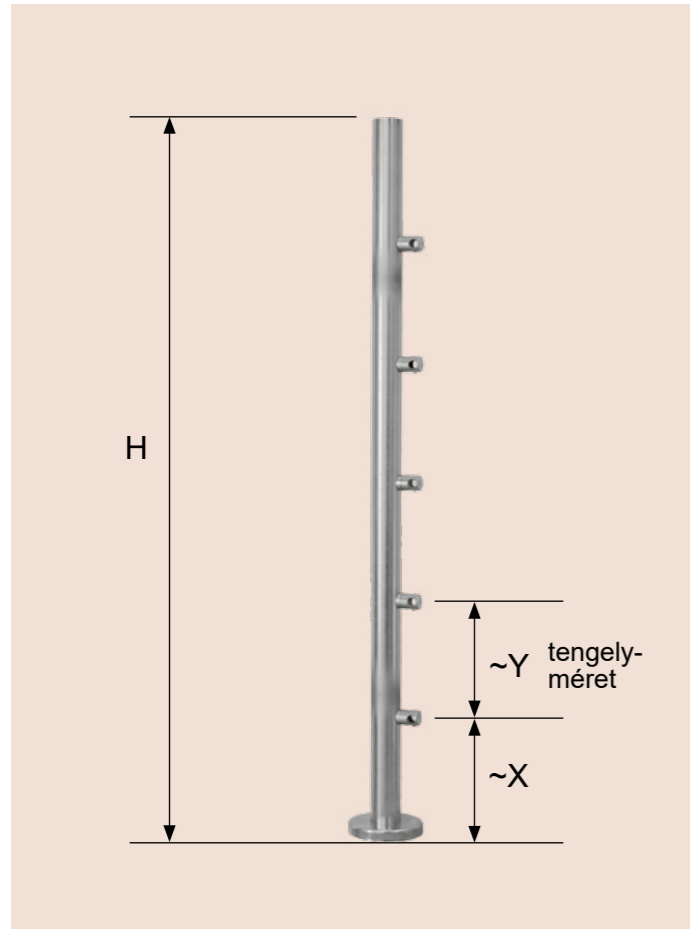

AISI 304	Cikkszám	Méret (mm)	H (mm)	X (mm)	Y (mm)	Vízszintes sorok száma	Párhuzamos szabadnyílás (mm)	Furatméret	Furatirány	Megj.
	RFE0282	Ø 42,4	1000	~ 179	~ 179	5	~ 167	Ø 12,2 mm	átmenő	raktáron
	RFE0282/J	Ø 42,4	1000	~ 179	~ 179	5	~ 167	Ø 12,2 mm	jobbos, zsákfurat	raktáron
	RFE0282/B	Ø 42,4	1000	~ 179	~ 179	5	~ 167	Ø 12,2 mm	balos, zsákfurat	raktáron
	RFE0300	Ø 42,4	1000	~ 154	~ 154	6	~ 142	Ø 12,2 mm	átmenő	rendelésre*
	RFE0300/J	Ø 42,4	1000	~ 154	~ 154	6	~ 142	Ø 12,2 mm	jobbos, zsákfurat	rendelésre*
	RFE0300/B	Ø 42,4	1000	~ 154	~ 154	6	~ 142	Ø 12,2 mm	balos, zsákfurat	rendelésre*
RFE0284	Ø 42,4	1200	~ 379	~ 179	5	~ 167	Ø 12,2 mm	átmenő	raktáron	
RFE0284/J	Ø 42,4	1200	~ 379	~ 179	5	~ 167	Ø 12,2 mm	jobbos, zsákfurat	raktáron	
RFE0284/B	Ø 42,4	1200	~ 379	~ 179	5	~ 167	Ø 12,2 mm	balos, zsákfurat	raktáron	
RFE0306	Ø 42,4	1200	~ 354	~ 154	6	~ 142	Ø 12,2 mm	átmenő	rendelésre*	
RFE0306/J	Ø 42,4	1200	~ 354	~ 154	6	~ 142	Ø 12,2 mm	jobbos, zsákfurat	rendelésre*	
RFE0306/B	Ø 42,4	1200	~ 354	~ 154	6	~ 142	Ø 12,2 mm	balos, zsákfurat	rendelésre*	

\*Szállítási határidő a megrendeléstől számított 2 hét!

AISI 304	Cikkszám	Méret (mm)	H (mm)	X (mm)	Y (mm)	Vízszintes sorok száma	Párhuzamos szabadnyílás (mm)	Furatméret	Furatirány	Megj.
	RFE0272	□ 40,0	900	~ 163	~ 163	5	~ 155	Ø 12,2 mm	átmenő	raktáron
	RFE0272/J	□ 40,0	900	~ 163	~ 163	5	~ 155	Ø 12,2 mm	jobbos, zsákfurat	raktáron
	RFE0272/B	□ 40,0	900	~ 163	~ 163	5	~ 155	Ø 12,2 mm	balos, zsákfurat	raktáron
	RFE0304	□ 40,0	900	~ 122	~ 122	7	~ 110	Ø 12,2 mm	átmenő	rendelésre*
	RFE0304/J	□ 40,0	900	~ 122	~ 122	7	~ 110	Ø 12,2 mm	jobbos, zsákfurat	rendelésre*
	RFE0304/B	□ 40,0	900	~ 122	~ 122	7	~ 110	Ø 12,2 mm	balos, zsákfurat	rendelésre*
RFE0274	□ 40,0	1105	~ 363	~ 163	5	~ 151	Ø 12,2 mm	átmenő	raktáron	
RFE0274/J	□ 40,0	1105	~ 363	~ 163	5	~ 151	Ø 12,2 mm	jobbos, zsákfurat	raktáron	
RFE0274/B	□ 40,0	1105	~ 363	~ 163	5	~ 151	Ø 12,2 mm	balos, zsákfurat	raktáron	
RFE0308	□ 40,0	1105	~ 322	~ 122	7	~ 110	Ø 12,2 mm	átmenő	rendelésre*	
RFE0308/J	□ 40,0	1105	~ 322	~ 122	7	~ 110	Ø 12,2 mm	jobbos, zsákfurat	rendelésre*	
RFE0308/B	□ 40,0	1105	~ 322	~ 122	7	~ 110	Ø 12,2 mm	balos, zsákfurat	rendelésre*	

\*Szállítási határidő a megrendeléstől számított 2 hét!

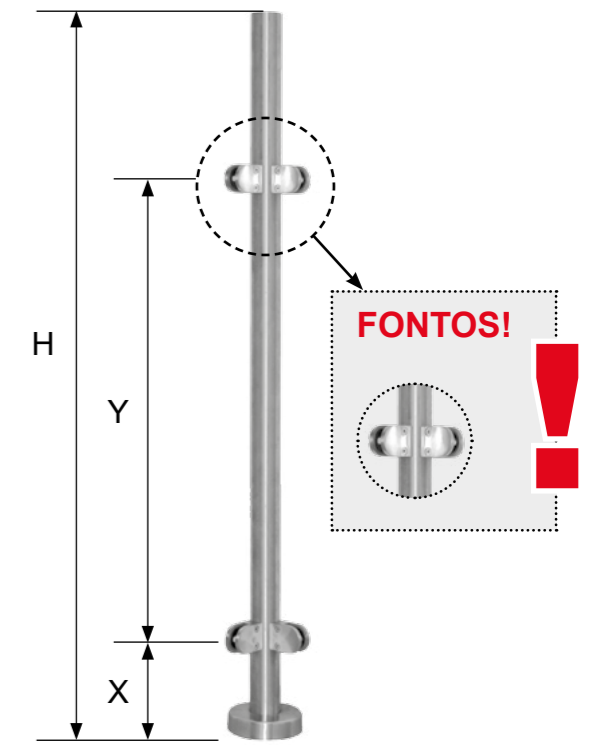
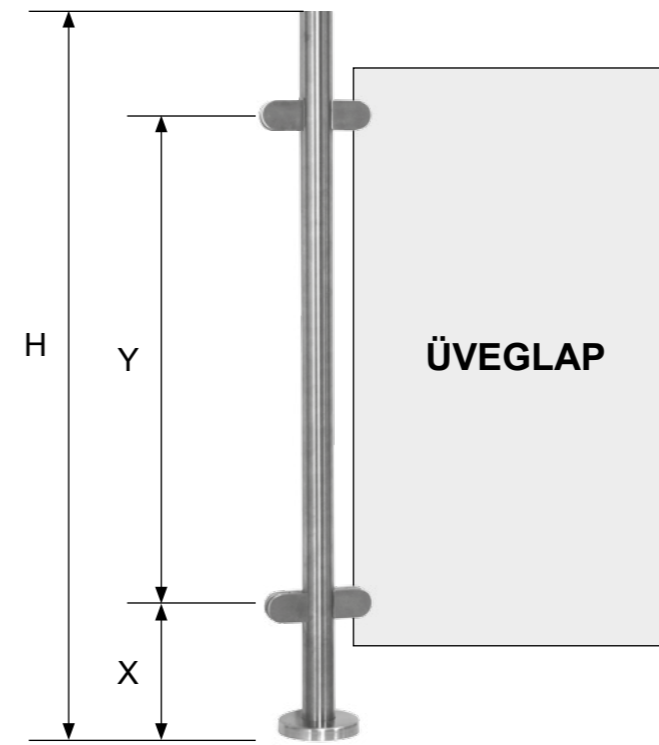
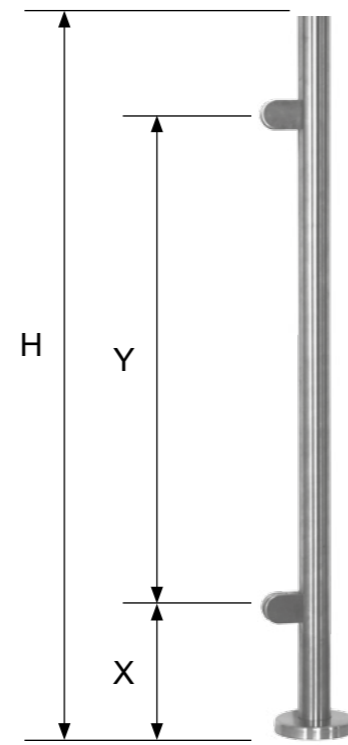
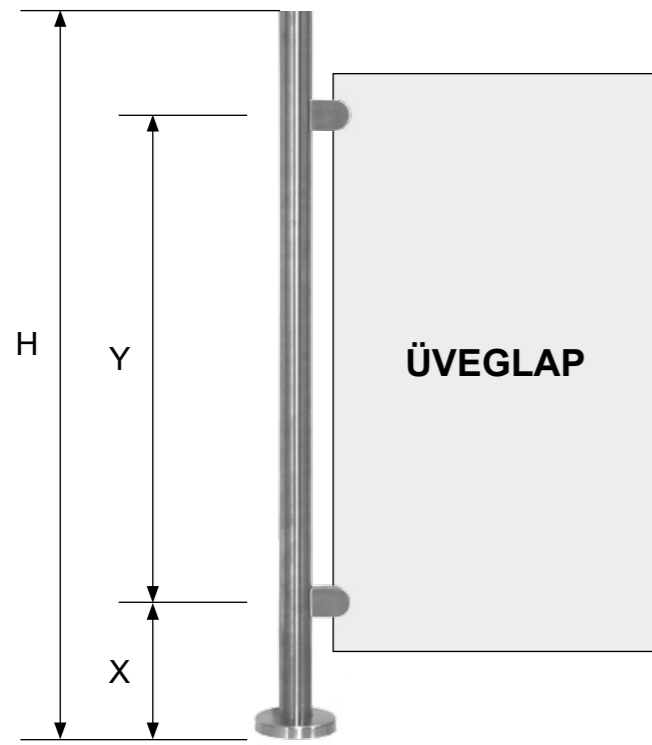

AISI 304	Cikkszám	Méret (mm)	H (mm)	X (mm)	Y (mm)
	<b>RFE0192*</b>	Ø 42,4	1000	100	800

AISI 304	Cikkszám	Méret (mm)	H (mm)	X (mm)	Y (mm)
	<b>RFE0196*</b>	Ø 42,4	1000	100	800

AISI 304	Cikkszám	Méret (mm)	H (mm)	X (mm)	Y (mm)
	<b>RFE0194*</b>	Ø 42,4	1000	100	800

AISI 304	Cikkszám	Méret (mm)	H (mm)	X (mm)	Y (mm)
	<b>RFE0197*</b>	Ø 42,4	1000	100	800

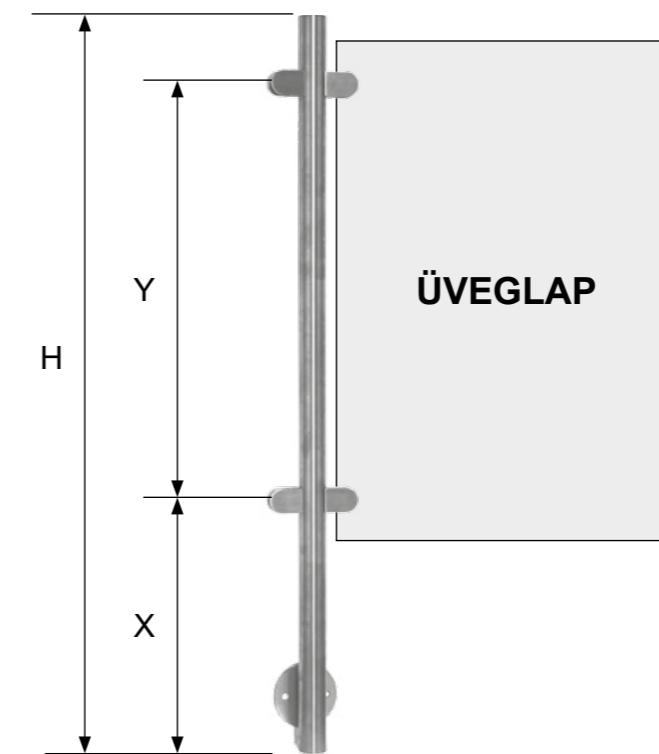
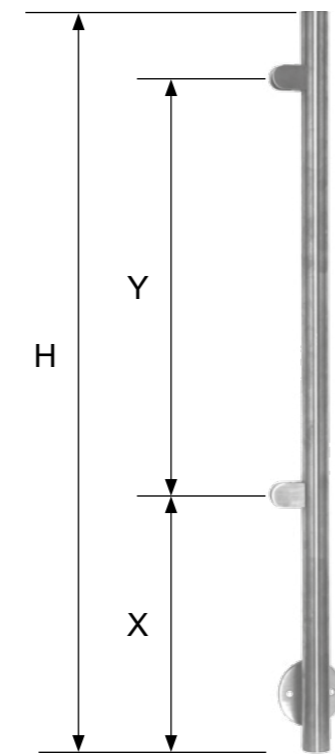
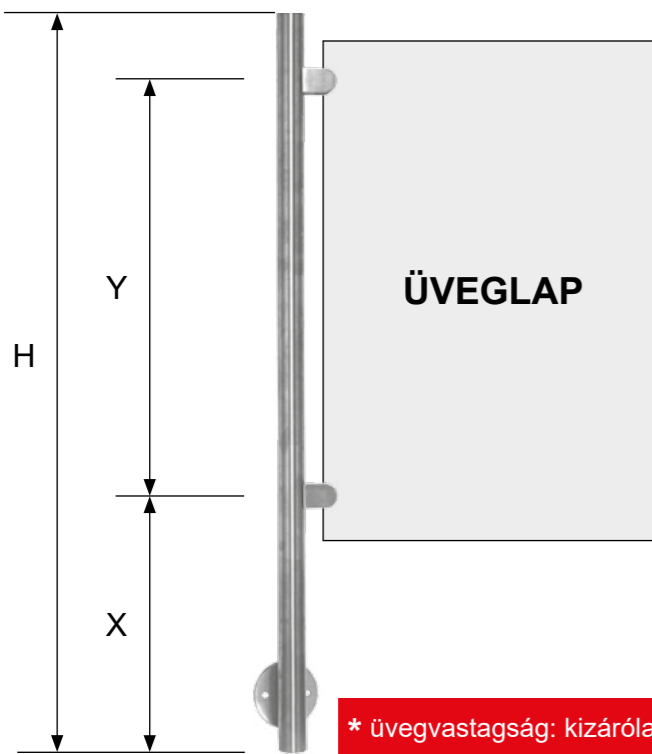

\* üvegvastagság: kizárólag 8 mm!

AISI 304	Cikkszám	Méret (mm)	H (mm)	X (mm)	Y (mm)
	<b>RFE0182*</b>	Ø 42,4	1200	300	800

AISI 304	Cikkszám	Méret (mm)	H (mm)	X (mm)	Y (mm)
	<b>RFE0186*</b>	Ø 42,4	1200	300	800

AISI 304	Cikkszám	Méret (mm)	H (mm)	X (mm)	Y (mm)
	<b>RFE0184*</b>	Ø 42,4	1200	300	800



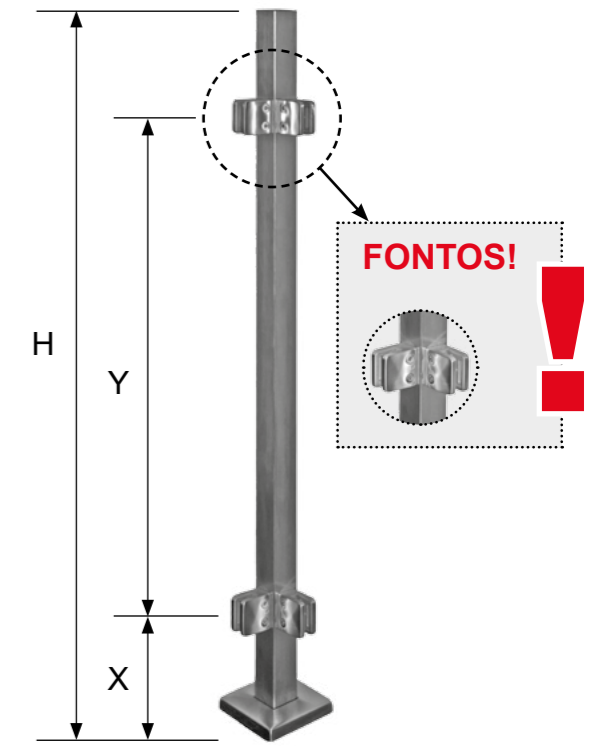
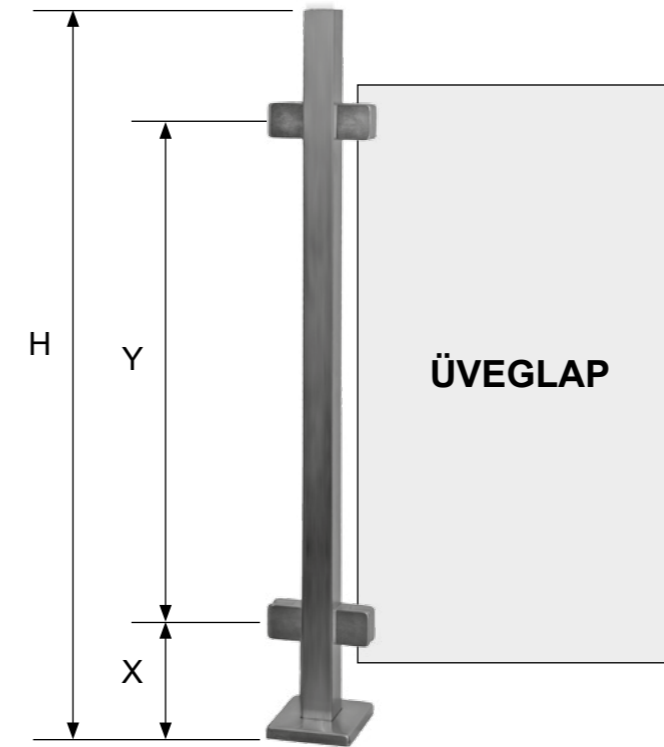
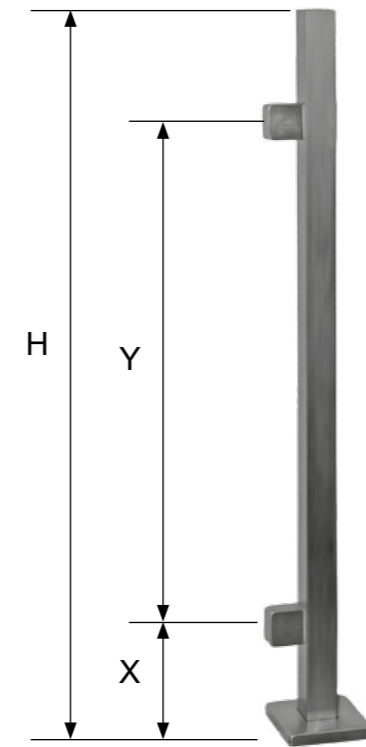
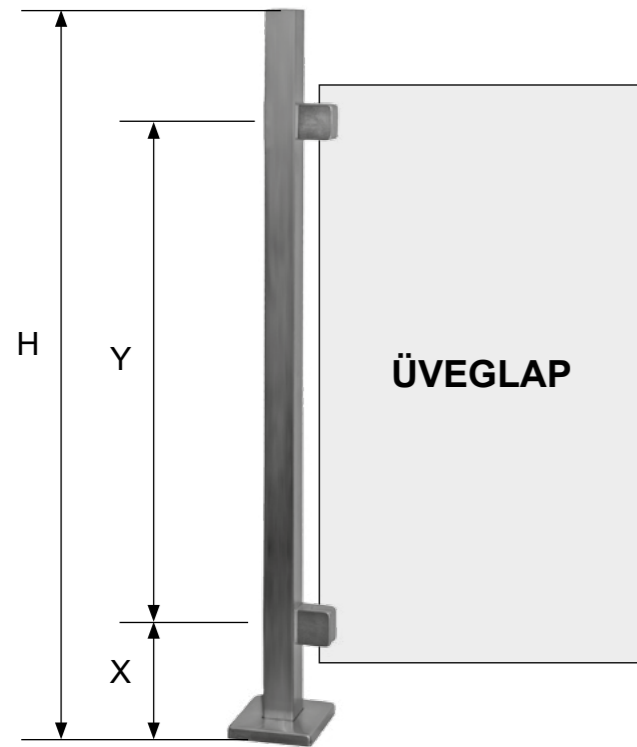

AISI 304	Cikkszám	Méret (mm)	H (mm)	X (mm)	Y (mm)
	<b>RFE0277*</b>	□ 40,0	900	100	700

AISI 304	Cikkszám	Méret (mm)	H (mm)	X (mm)	Y (mm)
	<b>RFE0278*</b>	□ 40,0	900	100	700

AISI 304	Cikkszám	Méret (mm)	H (mm)	X (mm)	Y (mm)
	<b>RFE0279*</b>	□ 40,0	900	100	700

AISI 304	Cikkszám	Méret (mm)	H (mm)	X (mm)	Y (mm)
	<b>RFE0280*</b>	□ 40,0	900	100	700

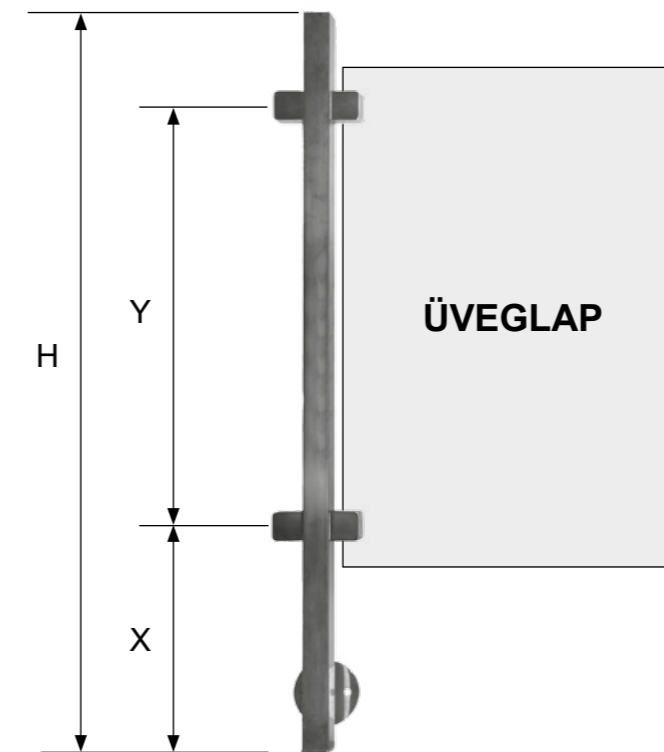
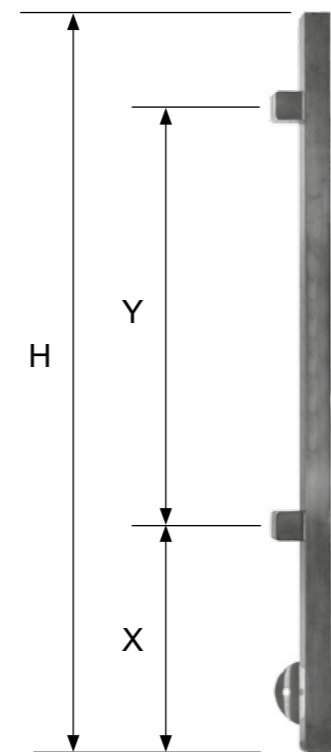
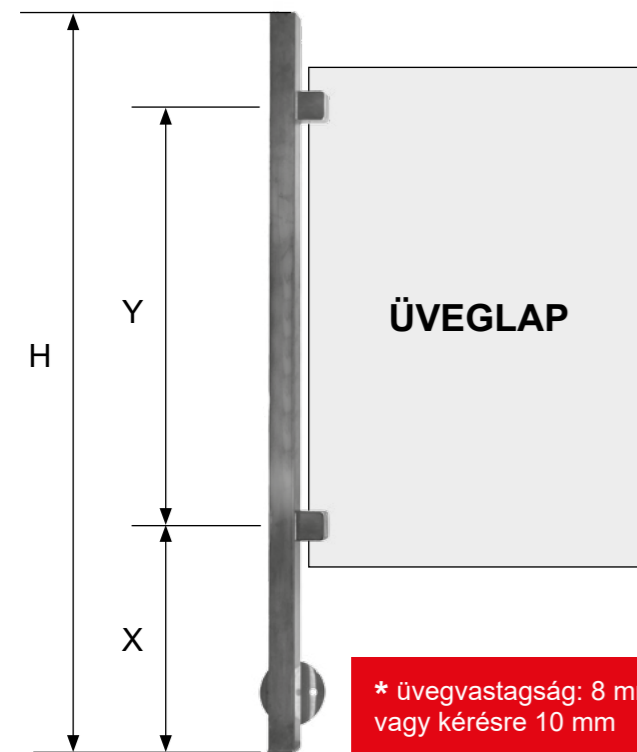

AISI 304	Cikkszám	Méret (mm)	H (mm)	X (mm)	Y (mm)
	<b>RFE0285*</b>	□ 40,0	1105	300	700

AISI 304	Cikkszám	Méret (mm)	H (mm)	X (mm)	Y (mm)
	<b>RFE0286*</b>	□ 40,0	1105	300	700

AISI 304	Cikkszám	Méret (mm)	H (mm)	X (mm)	Y (mm)
	<b>RFE0287*</b>	□ 40,0	1105	300	700



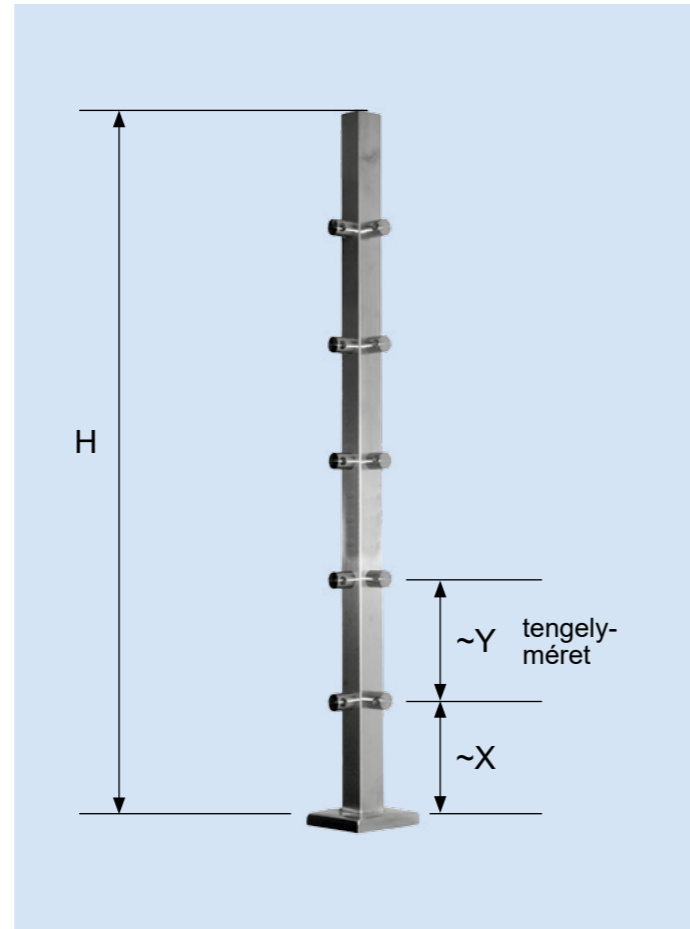
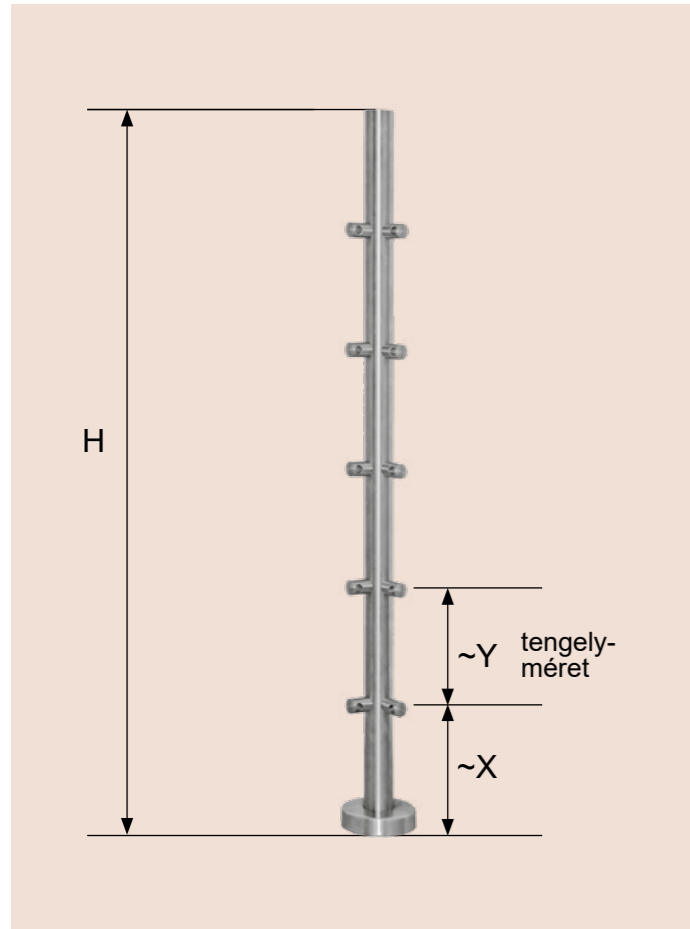

Cikkszám	Méret (mm)	H (mm)	X (mm)	Y (mm)	Vízszintes sorok száma	Párhuzamos szabadnyílás (mm)	Furatméret	Furatirány	Megj.
RFE0292	Ø 42,4	1000	~ 179	~ 179	5	~ 167	Ø 12,2 mm	átmenő	raktáron
RFE0292/J	Ø 42,4	1000	~ 179	~ 179	5	~ 167	Ø 12,2 mm	jobbos, zsákfurat	raktáron
RFE0292/B	Ø 42,4	1000	~ 179	~ 179	5	~ 167	Ø 12,2 mm	balos, zsákfurat	raktáron
RFE0302	Ø 42,4	1000	~ 154	~ 154	6	~ 142	Ø 12,2 mm	átmenő	rendelésre*
RFE0302/J	Ø 42,4	1000	~ 154	~ 154	6	~ 142	Ø 12,2 mm	jobbos, zsákfurat	rendelésre*
RFE0302/B	Ø 42,4	1000	~ 154	~ 154	6	~ 142	Ø 12,2 mm	balos, zsákfurat	rendelésre*
RFE0276	□ 40,0	900	~ 163	~ 163	5	~ 151	Ø 12,2 mm	átmenő	raktáron
RFE0276/J	□ 40,0	900	~ 163	~ 163	5	~ 151	Ø 12,2 mm	jobbos, zsákfurat	raktáron
RFE0276/B	□ 40,0	900	~ 163	~ 163	5	~ 151	Ø 12,2 mm	balos, zsákfurat	raktáron
RFE0305	□ 40,0	900	~ 122	~ 122	7	~ 110	Ø 12,2 mm	átmenő	rendelésre*
RFE0305/J	□ 40,0	900	~ 122	~ 122	7	~ 110	Ø 12,2 mm	jobbos, zsákfurat	rendelésre*
RFE0305/B	□ 40,0	900	~ 122	~ 122	7	~ 110	Ø 12,2 mm	balos, zsákfurat	rendelésre*

\*Szállítási határidő a megrendeléstől számított 2 hét!

AISI 304

**R 120 (fekete)**  
30×89×20 mm

**R 120/Z (galvanizált)**  
30×89×20 mm

**RF 122/Z3**  
50×74×15 mm

**RF 122/Z1**  
50×65×15 mm

**R 285.40**  
Ø 40 mm

**RF 122/Z4**  
50×105×15 mm

**RF 122/Z2**  
50×100×15 mm

**R 432C**  
M 18

**R 289.40P**  
állítható alsó zsanér

**R 231B.18C**  
M 18

**R 289.40**  
állítható alsó zsanér

**R 230.18C**  
M 18

**RF 9508**  
M18  
□ 80×80×8 mm

**RF 9507**  
M18  
□ 80×80×8 mm

**R 287.40P**  
állítható alsó zsanér

**R 241B.18**  
M 18

**R 287.40**  
állítható alsó zsanér

**R 240.18**  
M 18

**R 145F**  
Ütközési magasság:  
20-35 mm

**R 146F**  
Ütközési magasság:  
25-40 mm

**R 145**  
Ütközési felület  
70 × 18 mm

**R 146**  
Ütközési felület  
90 × 21 mm

**R 181/14**  
Ø 30×230 mm

**RF 9341**  
Ø 25×160 mm

**RF 9342**  
Ø 18×110 mm

**RF 247.18F**  
35×35 mm

RKC 7101.160

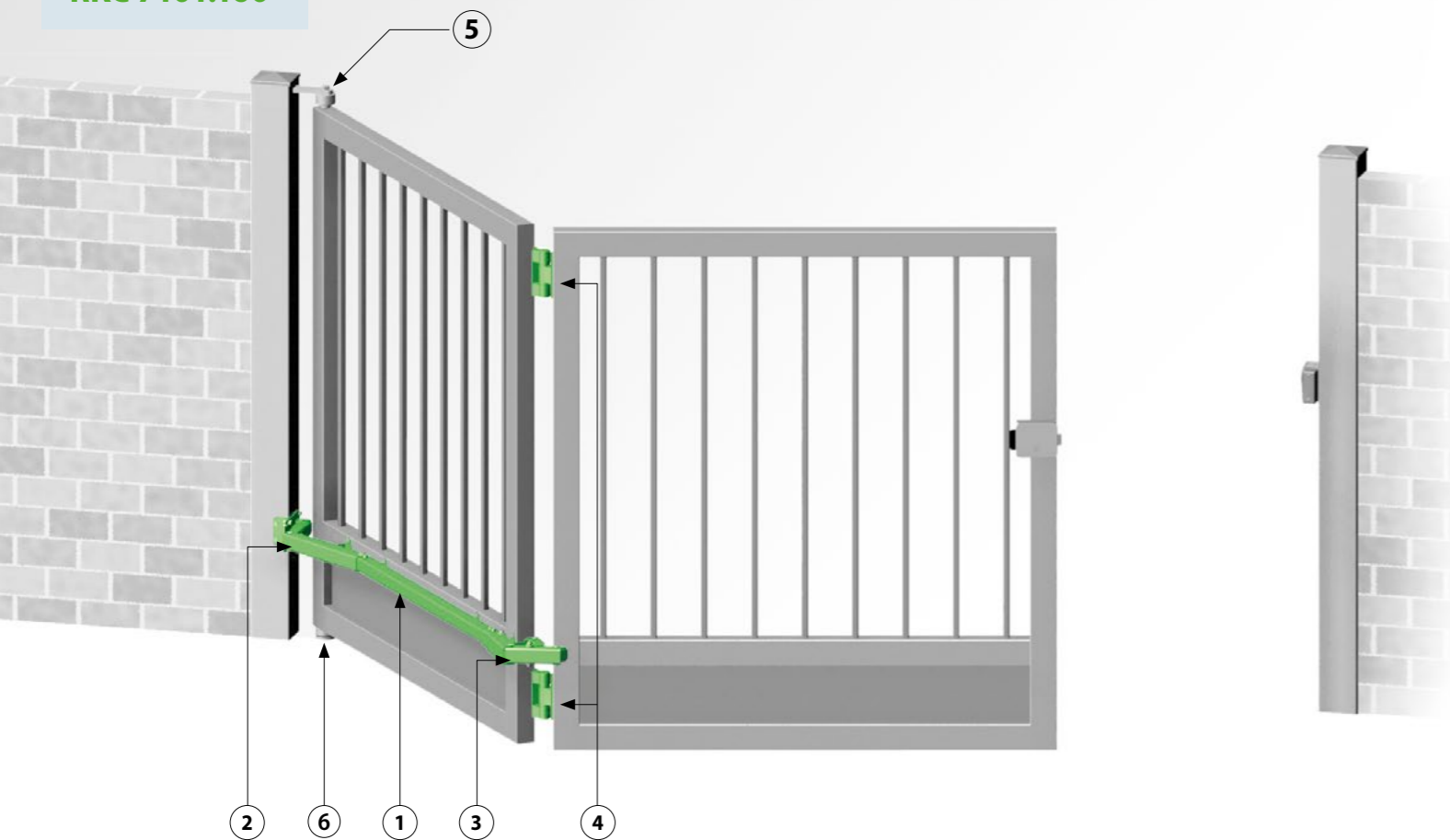

Tartozék lista



Egyszárnyú kapu két tagú

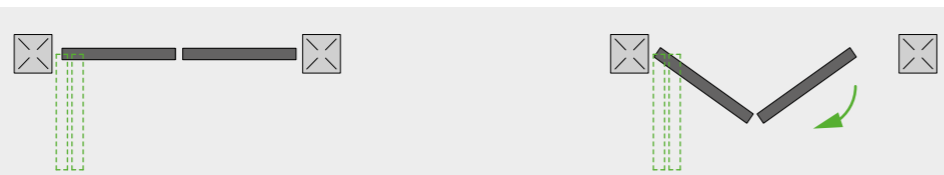

Kétszárnyú kapu négy tagú

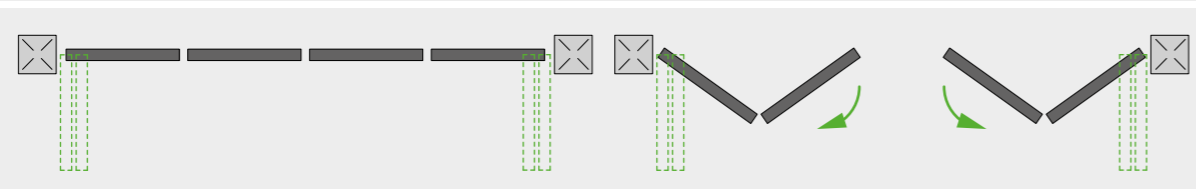

NYÍLÓKAPU EMELKEDŐ VASALAT

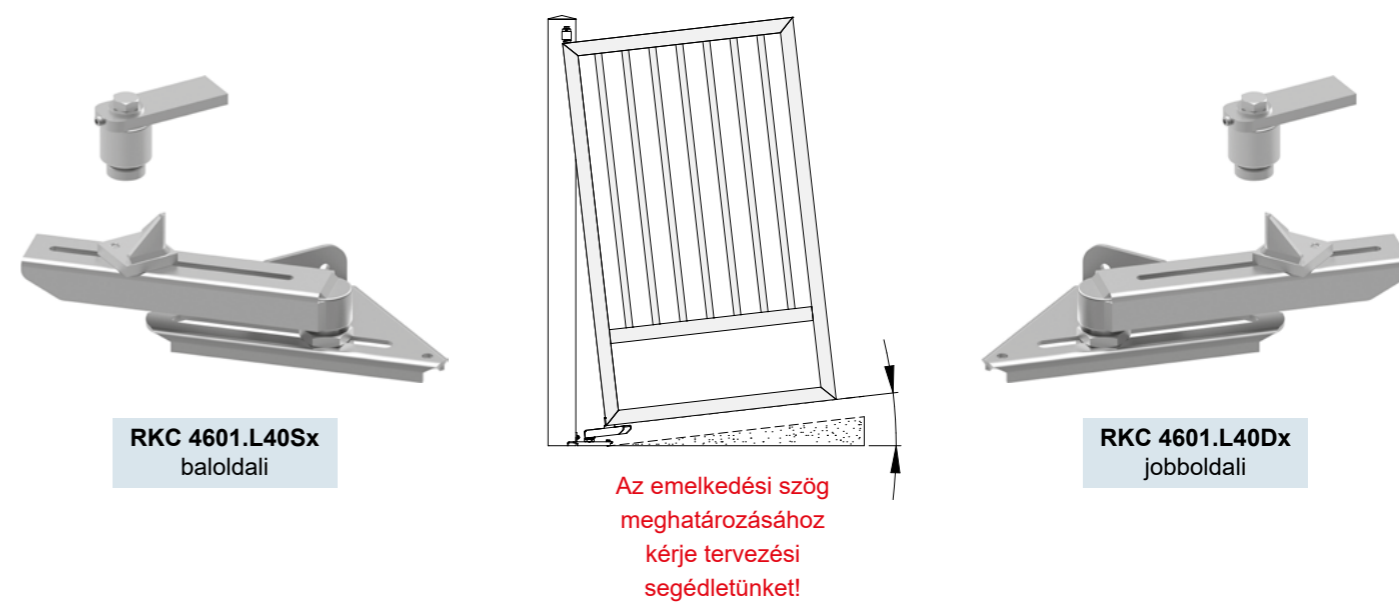

**TOLÓAJTÓ FELŐ SÍNPÁLYÁK**

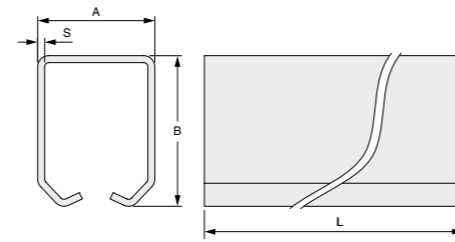
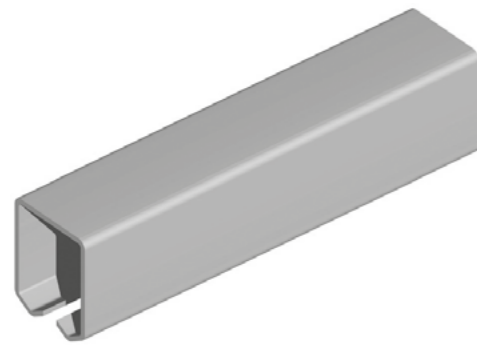

Rendelési szám	A	B	S	L (m)
RP.RF/24	33	31	2	6
RP.RF/24.3	33	31	2	3
RP.RF/45	42	54	2,5	6
RP.RF/45.3	42	54	2,5	3

**GALVANIZÁLT SÍNPÁLYÁK, BETONOZHATÓ, CSAVAROZHATÓ**



**R 723.75**  
Ø 75 mm, Ø 16 mm csőre  
terhelés: 200 kg



**R 101/16**  
Ø 75 mm, Ø 16 mm csőre  
terhelés: 200 kg

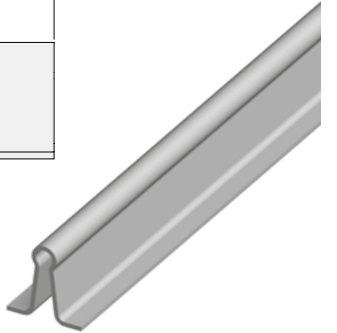
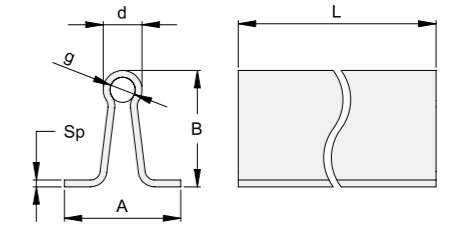

Rendelési szám	A	B	d	g	Sp.	L (m)
R816/Z	50	50	16	11	2,5	6
R816/Z3	50	50	16	11	2,5	3

**RÖGZÍTŐELEM OLDALFALRA ÉS MENNYEZETRE**

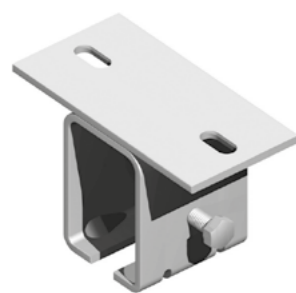

Rendelési szám
RSS 24
RSS 45



Rendelési szám
RSP 24
RSP 45

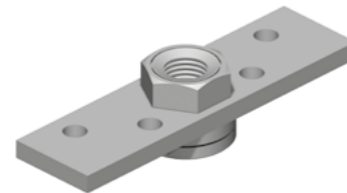

Rendelési szám	M12
VB3902.012	M12



**R 723.75**  
Ø 75 mm, Ø 16 mm csőre  
terhelés: 200 kg



**R 101/20**  
Ø 75 mm, Ø 20 mm csőre  
terhelés: 200 kg

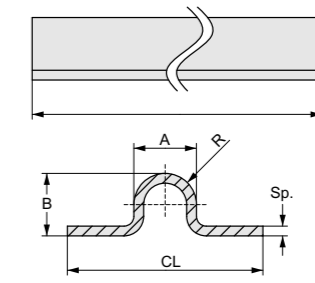

Rendelési szám	A	B	CL	R	Sp.	L (m)
R716/ZF	16	16	50	8	3	6
R716/Z3F	16	16	50	8	3	3
R720/ZF	20	16	55	10	3,5	6
R720/Z3F	20	16	55	10	3,5	3

**4 GÖRGŐS FELŐ GÖRGŐK**

Intenzív használatra is!



Rendelési szám	A	F	kg	Ø
R 4RC/45	45	M12	300	2

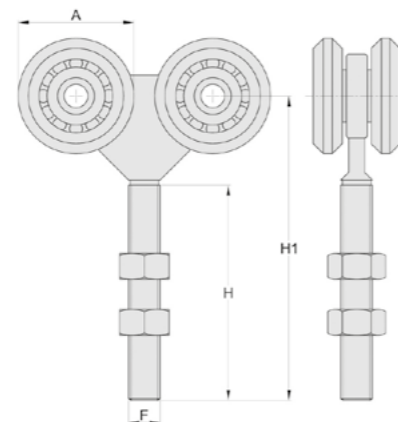

Intenzív használatra NEM ALKALMAS!



Rendelési szám	A	F	kg
R 4RF/24	24	M8	75



**R 721.75**  
Ø 75 mm,  
szögvasra  
terhelés: 180 kg



**R 101**  
Ø 75 mm,  
szögvasra  
terhelés: 200 kg



**R 101.60**  
Ø 60 mm,  
szögvasra  
terhelés: 100 kg

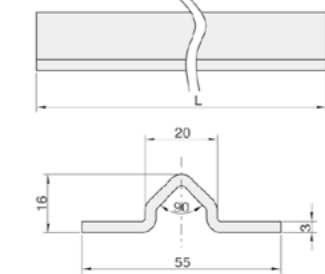

Rendelési szám	L (m)
R701/ZF	6
R701/Z3F	3



**R 412**  
Ø 34 mm,  
műanyag

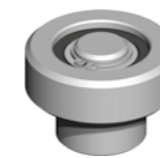

**R 159C**  
Ø 35 mm,  
csapágyazott acél

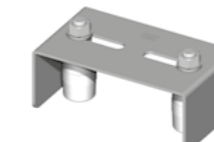

**R 220**  
befogás: 36-60 mm

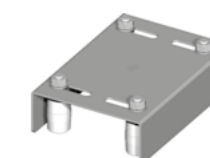

**R 221**  
befogás: 36-60 mm



**R 357.40**  
befogás: 44 mm



**RVA 4112.125**

Méretezési segédlet

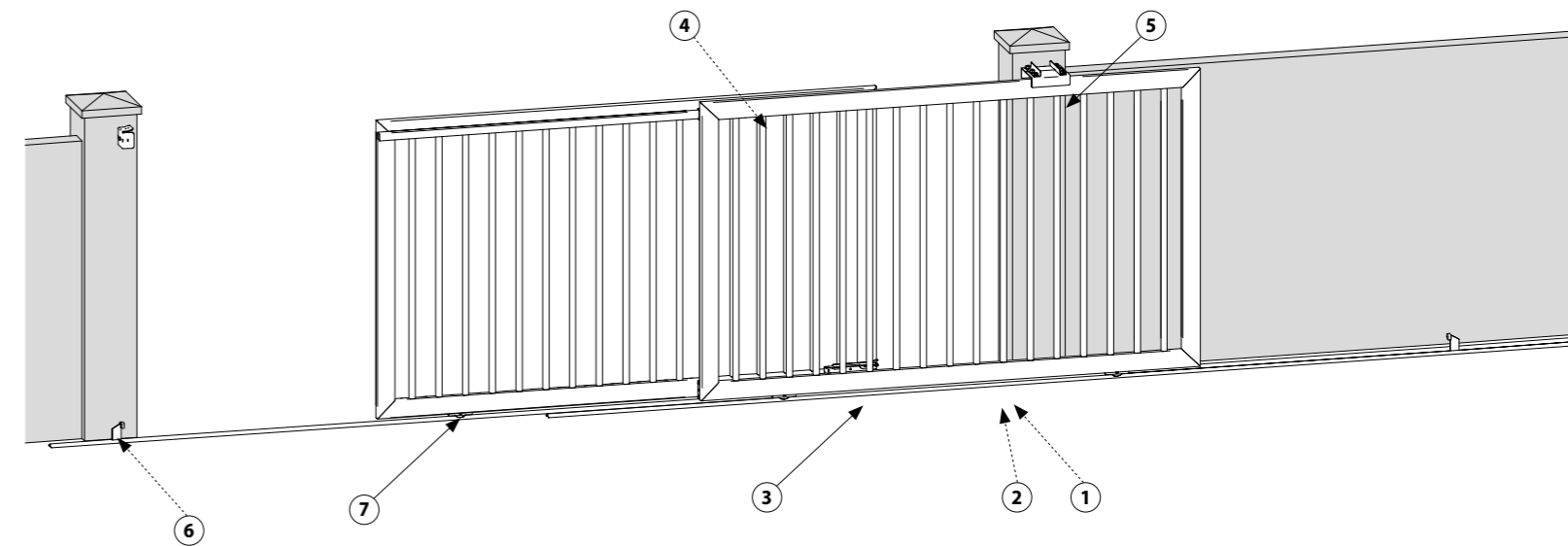
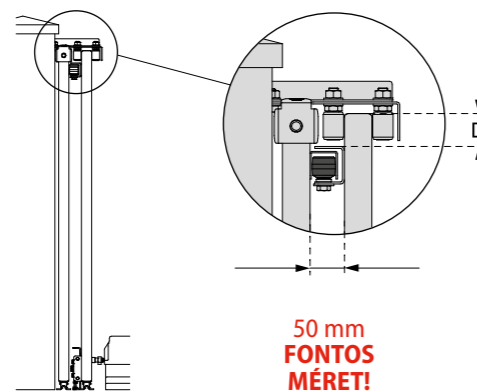
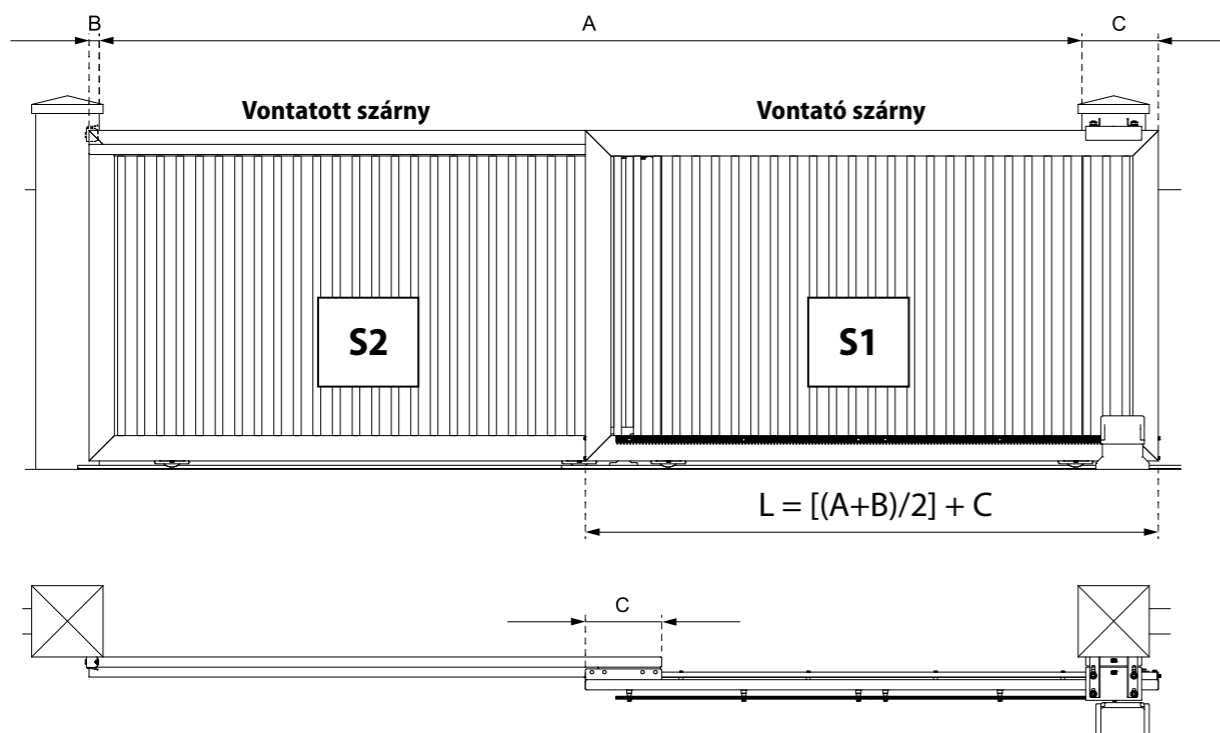

Tartozék lista

- |        |            |            |            |        |            |            |
|--------|------------|------------|------------|--------|------------|------------|
| ①      | ②          | ③          | ④          | ⑤      | ⑥          | ⑦          |
| VA5101 | VA5301.001 | VA5201.004 | VA3502.N34 | VA3501 | VA4101.092 | VA1104.090 |

**RKA5100.104**

**Kétszárnyú teleszkópos tolókapu rendszer 4 m szabadnyílásig**

ÚJ CIKKSZÁM	MEGNEVEZÉS	
VA3501.A30	Eldőlés elleni konzol görgőkkel	1
VA3502.N34	Görgősor	1
VA5101.004	Sodrony és tartozékai 4 m szabadnyílásig	1
VA5201.004	Gyorskuplung	1
VA5301.001	Sodrony takarás	2
VA4101.092	Hegeszthető véghelyzet ütköző	3
VA1104.090	Hegeszthető, vagy csavarozható kapugörgő V-profillal	4

Méretezési táblázat

ÚJ CIKKSZÁM	A max (m)	C (m)	D min (mm)	S2 max (kg)
RKA5100.004	4	0,3	50	300
RKA5100.008	8	0,3	50	300

Vontató szárny méretezése a szabadnyílás függvényében

ÚJ CIKKSZÁM	SZABADNYÍLÁS (A)	L (m), ha B=0,08
RKA5100.004	3	1,84
RKA5100.004	4	2,34
RKA5100.008	5	2,84
RKA5100.008	6	3,34
RKA5100.008	7	3,84
RKA5100.008	8	4,34

Méretezési példa

A = 3,5 m

B = 0,06 m

C = 0,3 m

$L = [(A+B)/2] + C$

$L = [(3,5+0,06)/2] + 0,3$

$L = [(3,56)/2] + 0,3$

$L = 1,78 + 0,3$

$L = 2,08$

**FIGYELEM!**

A vontatott szárny sebessége duplája a vontató szárny sebességének!

**RKA5100.108**

**Kétszárnyú teleszkópos tolókapu rendszer 8 m szabadnyílásig**

ÚJ CIKKSZÁM	MEGNEVEZÉS	
VA3501.A30	Eldőlés elleni konzol görgőkkel	1
VA3502.N34	Görgősor	1
VA5101.008	Sodrony és tartozékai 8 m szabadnyílásig	1
VA5201.004	Gyorskuplung	1
VA5301.001	Sodrony takarás	4
VA4101.092	Hegeszthető véghelyzet ütköző	3
VA1104.090	Hegeszthető, vagy csavarozható kapugörgő V-profillal	4

Méretezési segédlet

Felépítmény a kapu teljes hosszában

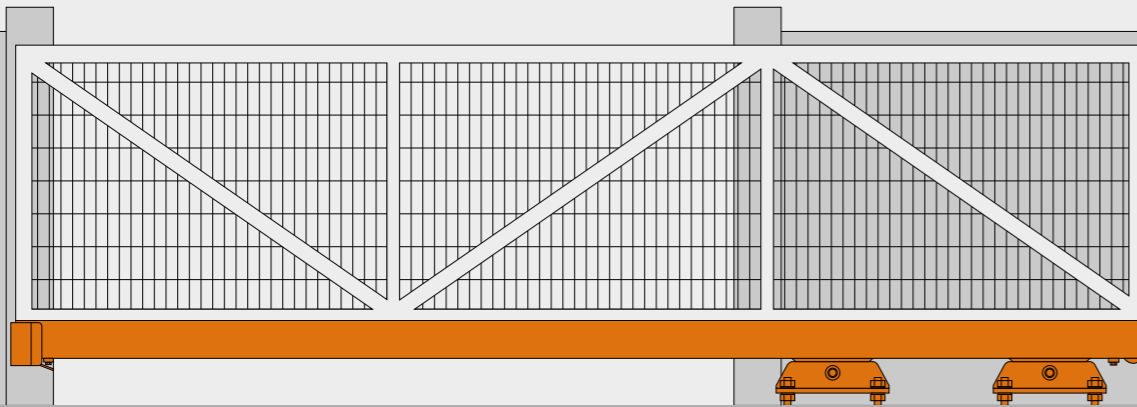

Felépítmény csak a szabadnyílásban

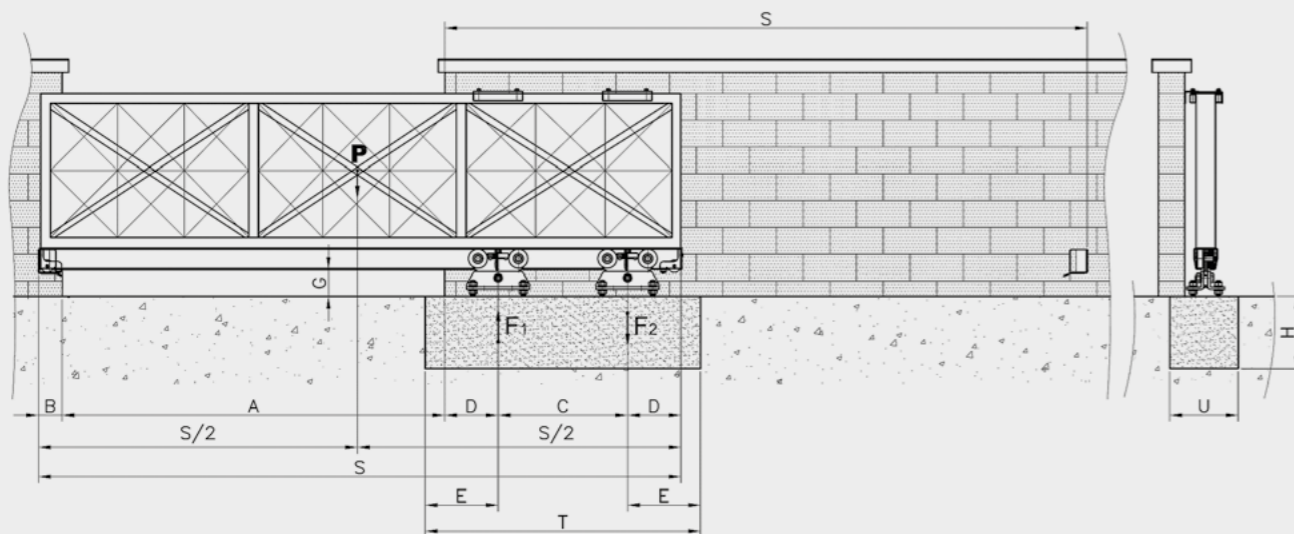
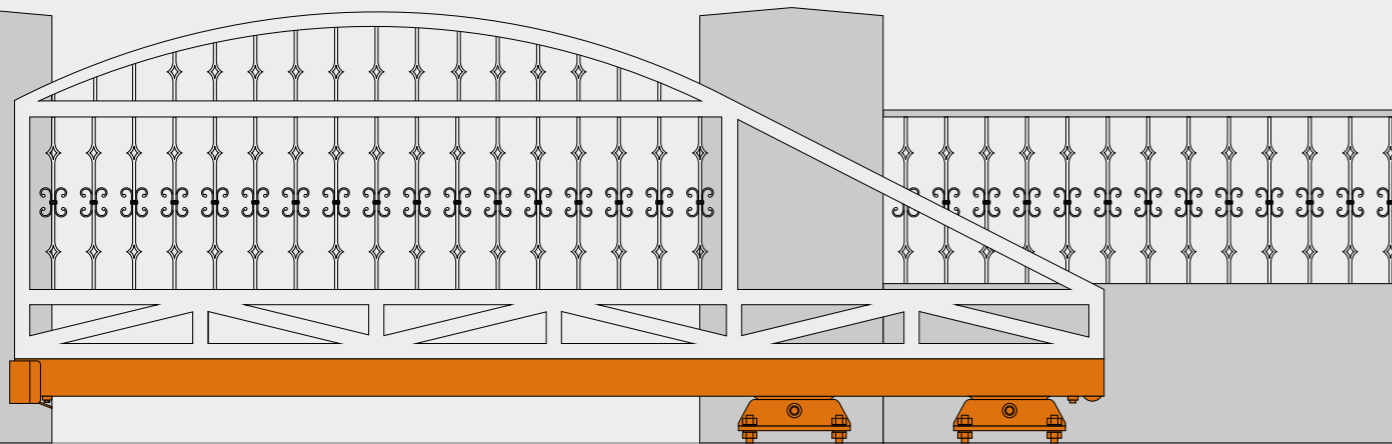

Méretek			T×U×H <sub>min</sub> (m)	Felépítmény a kapu teljes hosszában			Felépítmény csak a nyílásban		
A (m)	C (m)	S (m)		Kapu teljes súlya (max) 280 kg	Betontöke súlya (min) 560 kg	Felépítmény súlya [kg]	Kapu teljes súlya (max) 210 kg	Betontöke súlya (min) 730 kg	Felépítmény súlya [kg]
2	0,8	3,1	1,3×0,4×0,9			250			180
2,3	0,9	3,5	1,4×0,4×0,9			250			180
2,6	1,1	4,0	1,5×0,4×0,9			250			180
3	1,2	4,5	1,7×0,4×0,9			250			180
3,3	1,3	4,9	1,8×0,4×0,9			240			180
3,6	1,5	5,4	1,9×0,4×0,9			240			180
4	1,6	5,9	2,1×0,4×0,9			240			170
Fix adatok: F <sub>1max</sub> (kg): 500 D (m): 0,115 B (m): 0,070 G <sub>min</sub> (m): 0,05 E <sub>min</sub> (m): 0,25									

800-as család

Méretek			T×U×H <sub>min</sub> (m)	Felépítmény a kapu teljes hosszában			Felépítmény csak a nyílásban		
A (m)	C (m)	S (m)		Kapu teljes súlya (max) 450 kg	Betontöke súlya (min) 900 kg	Felépítmény súlya [kg]	Kapu teljes súlya (max) 340 kg	Betontöke súlya (min) 1210 kg	Felépítmény súlya [kg]
3	1,2	4,7	1,8×0,5×0,9			400			290
3,5	1,4	5,4	2,0×0,5×0,9			400			290
4	1,6	6,1	2,2×0,5×0,9			390			280
4,5	1,8	6,8	2,4×0,5×0,9			390			280
5	2,0	7,5	2,6×0,5×0,9			380			270
5,5	2,2	8,2	2,8×0,5×0,9			380			270
6	2,4	8,9	3,0×0,5×0,9			370			270
Fix adatok: F <sub>1max</sub> (kg): 800 D (m): 0,195 B (m): 0,110 G <sub>min</sub> (m): 0,06 E <sub>min</sub> (m): 0,30									

900-as család

Méretek			T×U×H <sub>min</sub> (m)	Felépítmény a kapu teljes hosszában			Felépítmény csak a nyílásban		
A (m)	C (m)	S (m)		Kapu teljes súlya (max) 565 kg	Betontöke súlya (min) 1110 kg	Felépítmény súlya [kg]	Kapu teljes súlya (max) 425 kg	Betontöke súlya (min) 1490 kg	Felépítmény súlya [kg]
3	1,2	4,8	1,9×0,6×0,9			600			450
3,5	1,4	5,5	2,1×0,6×0,9			600			450
4	1,6	6,2	2,3×0,6×0,9			600			450
4,5	1,8	6,9	2,5×0,6×0,9			600			450
5	2,0	7,6	2,7×0,6×0,9			600			450
5,5	2,2	8,3	2,9×0,6×0,9			600			450
6	2,4	9,0	3,1×0,6×0,9			600			450
7	2,8	10,4	3,5×0,6×0,9			600			450
8	3,2	11,8	3,9×0,6×0,9	600	450				
Fix adatok: F <sub>1max</sub> (kg): 1000 D (m): 0,260 B (m): 0,115 G <sub>min</sub> (m): 0,08 E <sub>min</sub> (m): 0,35									

1000-es család

Méretek			T×U×H <sub>min</sub> (m)	Felépítmény a kapu teljes hosszában			Felépítmény csak a nyílásban						
A (m)	C (m)	S (m)		Kapu teljes súlya (max) 850 kg	Betontöke súlya (min) 1655 kg	Felépítmény súlya [kg]	Kapu teljes súlya (max) 645 kg	Betontöke súlya (min) 2210 kg	Felépítmény súlya [kg]				
3	1,2	4,9	2,1×0,8×0,9			1200			900				
4	1,6	6,3	2,5×0,8×0,9			1200			900				
5	2,0	7,7	2,9×0,8×0,9			1200			900				
6	2,4	9,1	3,3×0,8×0,9			1200			900				
7	2,8	10,5	3,7×0,8×0,9			1200			900				
8	3,2	11,9	4,1×0,8×0,9			1200			900				
9	3,6	13,3	4,5×0,8×0,9			1200			900				
10	4	14,7	4,9×0,8×0,9			1200			900				
11	4,4	16,1	5,3×0,8×0,9			1200			900				
12	4,8	17,5	5,7×0,8×0,9			1200			900				
Fix adatok: F <sub>1max</sub> (kg): 1500 D (m): 0,290 B (m): 0,115 G <sub>min</sub> (m): 0,08 E <sub>min</sub> (m): 0,45													

2000-es család

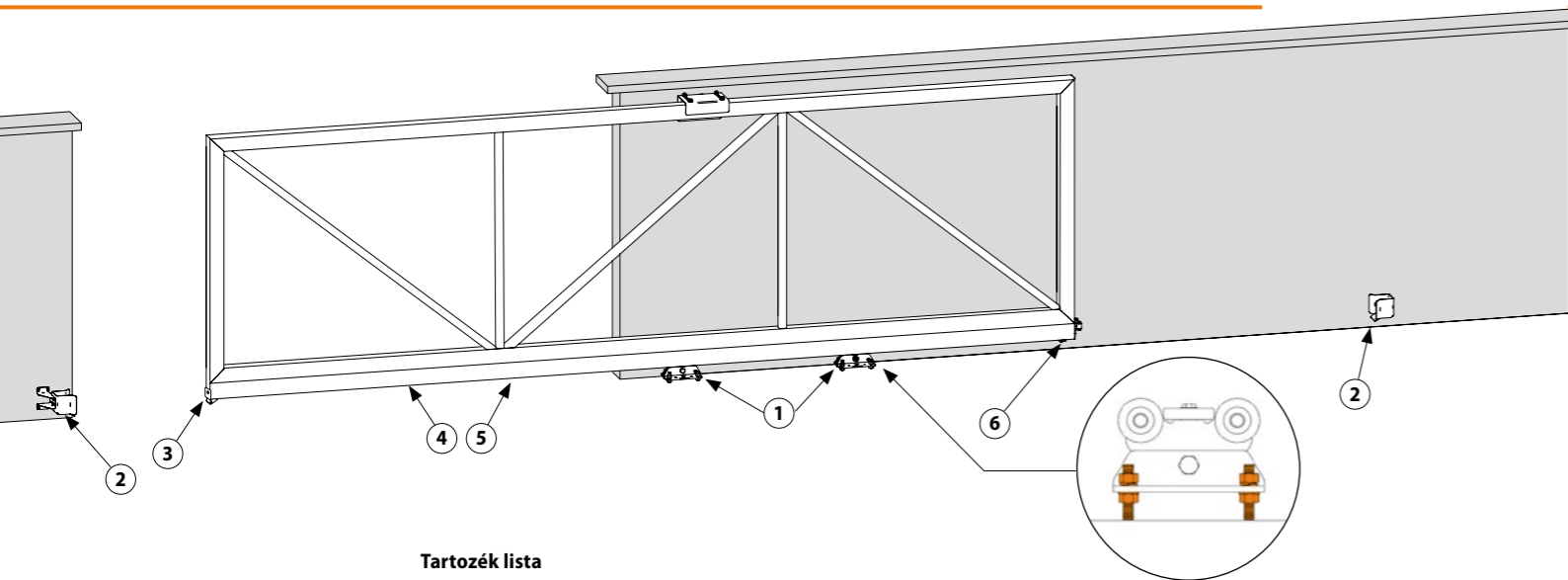

Tartozék lista

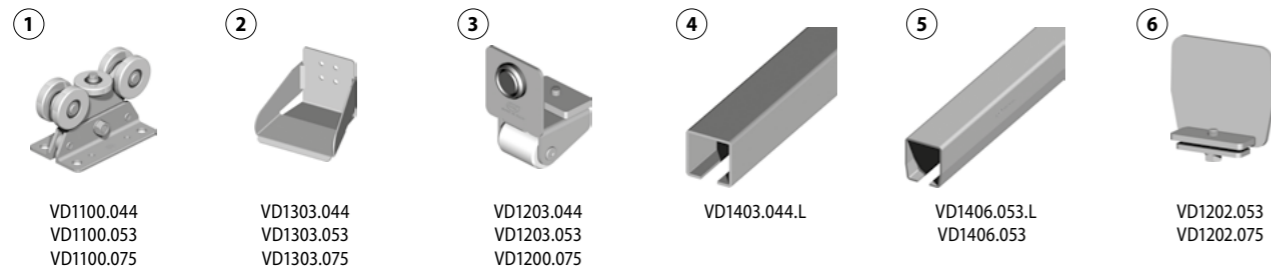

**RKD1000.080** Úszó-tolókapu rendszer max. 4 m szabadnyílásig / max. 170 kg kapusúlyig

ÚJ CIKKSZÁM	RÉGI CIKKSZÁM	MEGNEVEZÉS		800-as család
VD1100.044	R810	Görgőcsoport	2	
VD1203.044	R823	Végzáró kerékkel	1	
VD1303.044	R833	Fogadó	1	
VD1406.044.L	RP.44	"C"-metszetű szelvény – fekete, metszete 50x50x3,0 mm	1	

**RKD1000.090** Úszó-tolókapu rendszer max. 6 m szabadnyílásig / max. 270 kg kapusúlyig

ÚJ CIKKSZÁM	RÉGI CIKKSZÁM	MEGNEVEZÉS		900-as család
VD1100.053	R910S	Görgőcsoport	2	
VD1203.053	R923	Végzáró kerékkel	1	
VD1303.053	-	Fogadó	1	
VD1406.053.L	RP.53M	"C"-metszetű szelvény – fekete, metszete 60x70x3,5 mm	1	
VD1202.053	R925	Végzáró lemez	1	

**RKD1000.090/Z** Úszó-tolókapu rendszer max. 6 m szabadnyílásig / max. 270 kg kapusúlyig

ÚJ CIKKSZÁM	RÉGI CIKKSZÁM	MEGNEVEZÉS		900-as család
VD1100.053	R910S	Görgőcsoport	2	
VD1203.053	R923	Végzáró kerékkel	1	
VD1303.053	-	Fogadó	1	
VD1406.053	RP.53MZ	"C"-metszetű szelvény – horganyzott, metszete 60x70x3,5 mm	1	
VD1202.053	R925	Végzáró lemez	1	

**RKD1000.100** Úszó-tolókapu rendszer max. 8 m szabadnyílásig / max. 450 kg kapusúlyig

ÚJ CIKKSZÁM	RÉGI CIKKSZÁM	MEGNEVEZÉS		1000-es család
VD1100.075	R1010	Görgőcsoport	2	
VD1200.075	R1020	Végzáró kerékkel	1	
VD1303.075	-	Fogadó	1	
VD1202.075	R1025	Végzáró lemez	1	

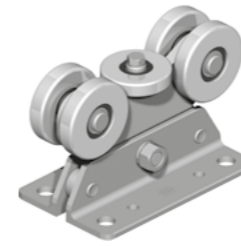

CIKKSZÁM	FELÜLET
R910S	cink/galv.
R1010	cink/galv.
R2010S	cink/galv.

CIKKSZÁM	GÖRGŐ CSOPORT	HOSSZ (m)	FELÜLET
RP.53/3	R910S	3	fekete
RP.53	R910S	6	fekete
RP.75/3	R1010	3	fekete
RP.75/4	R1010	4	fekete
RP.75	R1010	6	fekete
RP.100/3	R2010S	3	fekete
RP.100	R2010S	6	fekete
RP.53/Z/3	R910S	3	cink/galv.
RP.53/Z	R910S	6	cink/galv.
RP.75/Z/3	R1010	3	cink/galv.
RP.75/Z	R1010	6	cink/galv.
RP.100/Z/3	R2010S	3	cink/galv.
RP.100/Z	R2010S	6	cink/galv.



CIKKSZÁM	GÖRGŐCSOPORT	FELÜLET
R923	R910S	cink/galv.

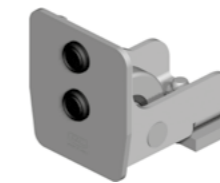

RÉGI CIKKSZÁM	GÖRGŐCSOPORT	FELÜLET
R920	R910S	cink/galv.
R1020	R1010	cink/galv.
R2020	R2010S	cink/galv.

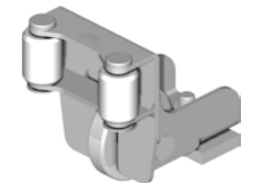

CIKKSZÁM	GÖRGŐCSOPORT	FELÜLET
R1021	R1010	cink/galv.
R2021	R2010S	cink/galv.

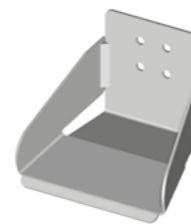

CIKKSZÁM	VÉGZÁRÓ	FELÜLET
R930	R920, R923	cink/galv.

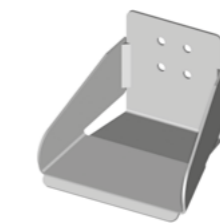

CIKKSZÁM	VÉGZÁRÓ	FELÜLET
R1030	R1020	cink/galv.
R2030.1	R2020	cink/galv.

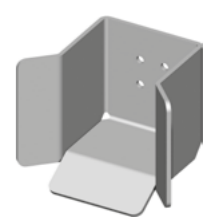

CIKKSZÁM	VÉGZÁRÓ	FELÜLET
R2031	R1021, R2021	cink/galv.

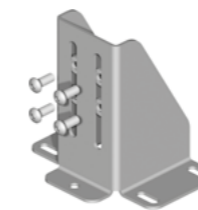

CIKKSZÁM	FOGADÓK	FELÜLET
R935	R930	cink/galv.
R1035	R1030, R2030	cink/galv.



CIKKSZÁM	"C"-METSZETŰ SZELVÉNY	FELÜLET
R925	RP.53	cink/galv.
R1025	RP.75	cink/galv.
R2025	RP.100	cink/galv.

